

# Table of Contents

	<u>Page</u>
GROUP 1: Engine .....	1
GROUP 2: Cooling .....	11
GROUP 3: Electrical .....	14
GROUP 4: Fuel - Exhaust - Emission .....	22
GROUP 5: Clutch .....	27
GROUP 6: Transmission - Transfer Case .....	T1
GROUP 7: Shift .....	30
GROUP 8: Brake .....	31
GROUP 9: Axle Propeller Shaft .....	40
GROUP 10: Steering - Suspension .....	51
GROUP 11: Springs - Shocks - Suspension .....	55
GROUP 12: Hoods - Fenders - Bumpers .....	60
GROUP 13: Heater .....	62
GROUP 15: Mirrors - Accessories .....	63
GROUP 16-18: Auto Trans - Transfer Case .....	66
Transfer Case (charts) .....	T18
GROUP 22: Windshield Wiper .....	67
GROUP 23: Tailgate - Windshield - Channel .....	68
KIT SECTION .....	69
INDEX .....	75

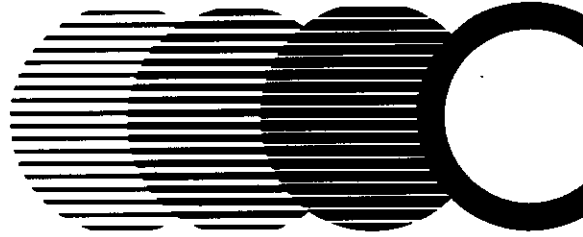

**Crown Automotive Sales Co., Inc.**

Independent Distributor of Replacement Parts for Jeep® Vehicles

## **FAST REFERENCE PARTS CATALOG**

**JEEP® VEHICLES 1979-1989**



**CJ-5**



**CJ-7**



**CJ-8**



**WRANGLER**

PLEASE NOTE:

Part numbers listed in this catalog are for reference purposes only, No implication is given that ordered from Crown will necessarily be the original equipment replacement.

No guarantee is given as to the accuracy of this catalog. It is intended as a fast reference book for the convenience of our customers.

Please note that part numbers listed are primarily targeted for vehicles sold in the United States. There may be some discrepancies in vehicles built for export, or in some cases, California. In these cases, consult original equipment catalogs for proper fit.

Crown Automotive Sales Co., Inc.  
is not affiliated with Jeep Corporation.

Copyright © 1990 Crown Automotive Sales Co., Inc.

All right reserved. No parts of this catalog may be reproduced in any form or by any means.

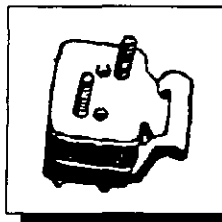

1.009

**INSULATOR, Front Engine Mount**

4 Cyl : CJ, 1980-86 use J5361829  
 4 Cyl : Wr, 1987-89 use 52000074  
 6 Cyl : CJ, 1979-86 use J8128488  
 6 Cyl : Wr, 1987-89 use 52040267  
 8 Cyl : CJ, 1979-81 use J3226821

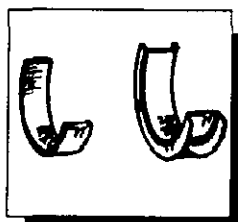

1.023

**BEARING, Main - STD**

4 Cyl. - # 5; 6 & 8 Cyl. - # 3  
 4 Cyl : CJ, 1980-82 use J8132214  
 4 Cyl : CJ, 1983-86 use J8133253  
 4 Cyl : Wr, 1987-89 use J8133253  
 6 Cyl : CJ, 1979-80 use J3207959  
 6 Cyl : CJ, 1981-86 use J8133253  
 6 Cyl : Wr, 1987-89 use J8133253  
 8 Cyl : CJ, 1979-81 use J8125933



1.022

**CAP, Oil Filler**

4 Cyl : CJ, 1980-81 use J8132312  
 4 Cyl : CJ, 1982 use J8134401  
 4 Cyl : CJ, 1983-86 use 33001016  
 4 Cyl : Wr, 1987-89 use 33001016  
 6 Cyl : CJ, 1979 use J3174645  
 6 Cyl : CJ, 1980 use J3236687  
 6 Cyl : CJ, 1981-82 use J3238659  
 6 Cyl : CJ, 1983-86 use 33001016  
 6 Cyl : Wr, 1987-89 use 33001016  
 8 Cyl : CJ, 1979-81 use J3220248

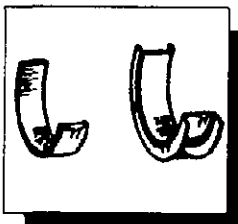

1.023

**BEARING, Main - .010**

4 Cyl. - # 5; 6 & 8 Cyl. - # 3  
 4 Cyl : CJ, 1980-82 use J8132217  
 4 Cyl : CJ, 1983-86 use J8133255  
 4 Cyl : Wr, 1987-89 use J8133255  
 6 Cyl : CJ, 1979-86 use J8133255  
 6 Cyl : Wr, 1987-89 use J8133255  
 8 Cyl : CJ, 1979-81 use J8125936

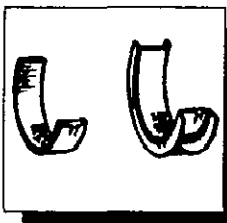

1.023

**BEARING, Main - STD**

4 Cyl. - #1,2,3,4; 6 Cyl. - # 1,2,4,5 (6,7)  
 4 Cyl : CJ, 1980-82 use J8132210  
 4 Cyl : CJ, 1983-86 use J8133252  
 4 Cyl : Wr, 1987-89 use J8133252  
 6 Cyl : CJ, 1979-80 use J3207954  
 6 Cyl : CJ, 1981-86 use J8133252  
 6 Cyl : Wr, 1987-89 use J8133252  
 8 Cyl : CJ, 1979-81 use J8125928

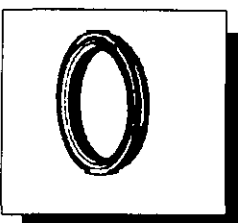

1.032

**SEAL KIT, Rear Main Bearing Cap**

4 Cyl : CJ, 1980-82 use J8132218  
 4 Cyl : CJ, 1983-86 use J3241669  
 4 Cyl : Wr, 1987-89 use J3241669  
 6 Cyl : CJ, 1979-86 use J3205331  
 6 Cyl : Wr, 1987-89 use J3205331  
 8 Cyl : CJ, 1979-81 use J3206691

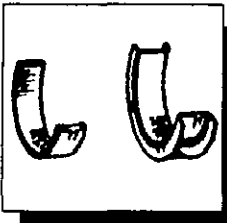

1.023

**BEARING, Main - .010**

4 Cyl. - #1,2,3,4; 6 Cyl. - # 1,2,4,5 (6,7)  
 4 Cyl : CJ, 1980-82 use J8132213  
 4 Cyl : CJ, 1983-86 use J8133254  
 4 Cyl : Wr, 1987-89 use J8133254  
 6 Cyl : CJ, 1979-80 use J3207957  
 6 Cyl : CJ, 1981-86 use J8133254  
 6 Cyl : CJ, 1987-89 use J8133254  
 8 Cyl : CJ, 1979-81 use J8125931

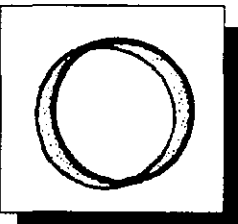

1.038

**PLUG, Cylinder Block Core Hole**

4 Cyl : CJ, 1980-82 use J8132204<sup>1</sup>  
 4 Cyl : CJ, 1983-86 use J3105394<sup>2</sup>  
 4 Cyl : Wr, 1987-89 use J3105394  
 6 Cyl : CJ, 1979-86 use J3105394<sup>3</sup>  
 6 Cyl : Wr, 1987-89 use J3105394  
 8 Cyl : CJ, 1979-81 use J3144641<sup>2</sup>

**NOTE:**

1. FOR DIAMETER 41.5MM USE J8132207. FOR 5.8" DIAMETER USE G9427693.
2. FOR DIAMETER OF 1 3/4" USE J4006580.
3. FOR 1981-86, FOR 1" DIAMETER USE J3178449.

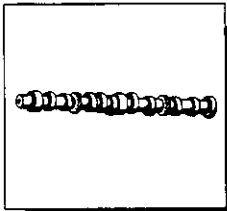

**1.040**

**CAMSHAFT**

4 Cyl : CJ, 1980-82 use J8132249  
 4 Cyl : CJ, 1983-86 use 83500249  
 4 Cyl : Wr, 1987-89 use 83500249

6 Cyl : CJ, 1979-80 use J8120663  
 6 Cyl : CJ, 1981-86 use J8133009  
 6 Cyl : Wr, 1987-89 use J8133009

8 Cyl : CJ, 1979-81 use J8129668

**NOTE:** 1. WITH HYDRAMATIC TRANSMISSION USE J8126514.

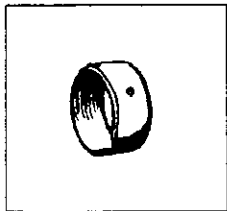

**1.041**

**BEARING SET, Camshaft - STD**

4 Cyl : CJ, 1980-82 use J8132250  
 4 Cyl : CJ, 1983-86 use J3205711  
 4 Cyl : Wr, 1987-89 use J3205711

6 Cyl : CJ, 1979-86 use J3205711  
 6 Cyl : Wr, 1987-89 use J3205711

8 Cyl : CJ, 1979-81 use J4486286

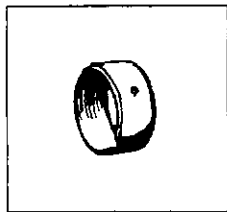

**1.041**

**BEARING SET, Camshaft - .010**

4 Cyl : CJ, 1983-86 use J3208985  
 4 Cyl : Wr, 1987-89 use J3208985

6 Cyl : CJ, 1979-86 use J3208985  
 6 Cyl : Wr, 1987-89 use J3208985

8 Cyl : CJ, 1979-81 use J4486890

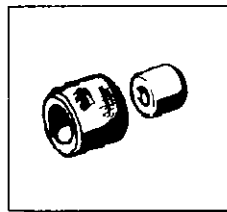

**1.043**

**BUSHING, Crankshaft Pilot**

4 Cyl : CJ, 1980-82 use J8132261  
 4 Cyl : CJ, 1983-86 use J3250005  
 4 Cyl : Wr, 1987-89 use J3250005

6 Cyl : CJ, 1979 use J3222723  
 6 Cyl : CJ, 1980-86 use J3236726  
 6 Cyl : Wr, 1987-89 use 33001041

8 Cyl : CJ, 1979 use J3222723  
 8 Cyl : CJ, 1980-81 use J3236726

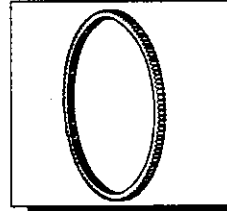

**1.056**

**GEAR, Flywheel Ring**

4 Cyl : CJ, 1980-82 use J3179741  
 4 Cyl : CJ, 1983-86 use J3241718  
 4 Cyl : Wr, 1987-89 use J3241718

6 Cyl : CJ, 1979-86 use J3179741  
 6 Cyl : Wr, 1987-89 use J3179741

8 Cyl : CJ, 1979-81 use J3179741

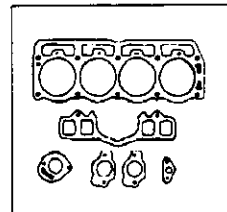

**1.060**

**GASKET SET, Engine Valve Grind**

4 Cyl : CJ, 1980-81 use J8132203  
 4 Cyl : CJ, 1982 use J8134134  
 4 Cyl : CJ, 1983 use J8134689<sup>1</sup>  
 4 Cyl : CJ, 1984-85 use 83500255<sup>2</sup>  
 4 Cyl : CJ, 1986 use 83502501<sup>3</sup>  
 4 Cyl : Wr, 1987 use 83502501  
 4 Cyl : Wr, 1988-89 use 83504346

6 Cyl : CJ, 1979-80 use J8128190  
 6 Cyl : CJ, 1981-85 use J8133352<sup>2</sup>  
 6 Cyl : CJ, 1986 use 83502384<sup>3</sup>  
 6 Cyl : Wr, 1987-89 use 83502384

8 Cyl : CJ, 1979-81 use J8128191

**NOTE:**

1. FOR 1983 AMC 4 CYLINDER ENGINE USE 83500255.
2. USED ON ENGINES W/ 7/16" DIAMETER CYLINDER HEAD MOUNTING BOLTS.
3. USED ON ENGINES W/ 1/2" DIAMETER CYLINDER HEAD MOUNTING BOLTS.

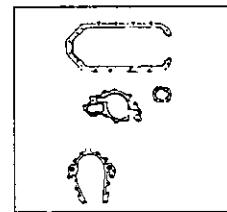

**1.060**

**GASKET SET, Engine Overhaul (Engine Lower)**

4 Cyl : CJ, 1980-81 use J8132202  
 4 Cyl : CJ, 1982 use J8134322  
 4 Cyl : CJ, 1983 use J8134688<sup>1</sup>  
 4 Cyl : CJ, 1984-86 use 83500256  
 4 Cyl : Wr, 1987-89 use 83500256

6 Cyl : CJ, 1979-80 use J8125722  
 6 Cyl : CJ, 1981-86 use J8133353  
 6 Cyl : Wr, 1987-89 use J8133353

8 Cyl : CJ, 1979-81 use J8125727

**NOTE:**

1. FOR AMC ENGINE USE 83500256.

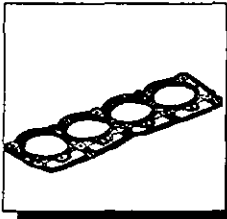

1.061

**GASKET, Cylinder Head**

4 Cyl : CJ, 1980-81 use J8132222  
 4 Cyl : CJ, 1982-83 use J8133701  
 4 Cyl : CJ, 1984-85 use J3241649<sup>2</sup>  
 4 Cyl : CJ, 1986 use 33002419<sup>3</sup>  
 4 Cyl : Wr, 1987-89 use 33002419<sup>4</sup>

6 Cyl : CJ, 1979-80 use J3228469  
 6 Cyl : CJ, 1981-85 use J3237756  
 6 Cyl : CJ, 1986 use J3228469  
 6 Cyl : Wr, 1987-89 use J3228469

8 Cyl : CJ, 1979-81 use J3197636

**NOTE:**

1. FOR 1983, FOR AMC ENGINE USE J3241649.
2. USED ON ENGINE W/ 7/16" DIAMETER CYLINDER HEAD MOUNTING BOLTS.
3. USED ON ENGINE W/ 1/2" DIAMETER BOLTS.
4. NUMBER SHOWN IS FOR SILVER. FOR BLUE USE 33003722.

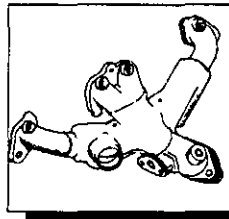

1.067

**MANIFOLD, Exhaust**

4 Cyl : CJ, 1980-81 use J8132339  
 4 Cyl : CJ, 1982 use J8134158  
 4 Cyl : CJ, 1983-85 use J3242625<sup>1</sup>  
 4 Cyl : CJ, 1986 use 33002509  
 4 Cyl : Wr, 1987-89 use 33002509

6 Cyl : CJ, 1979 use J8124999  
 6 Cyl : CJ, 1980 use J3236582  
 6 Cyl : CJ, 1981-82 use J3237427  
 6 Cyl : CJ, 1983-86 use J3237426  
 6 Cyl : Wr, 1987-89 use J3237427<sup>2</sup>

8 Cyl : CJ, 1979-81 use J8122442<sup>3</sup>

**NOTE:**

1. FOR 1983, FOR GM MODEL USE J8134697.
2. FOR MANIFOLD W/ PLUGGED VENT HOLES USE 33000584.
3. FOR RIGHT SIDE USE J8121274.

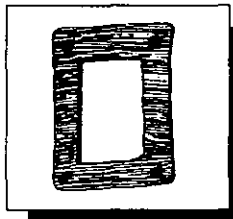

1.067

**GASKET, Intake Manifold to Exhaust Manifold**

6 Cyl : CJ, 1979-80 use 3184277

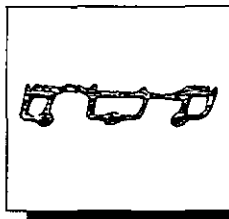

1.067

**GASKET, Exhaust Manifold to Cylinder Head**

4 Cyl : CJ, 1980-83 use J8132340

8 Cyl : CJ, 1980-81 use J3237270

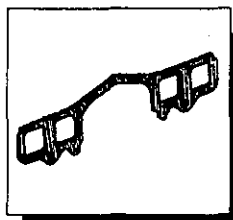

1.067

**GASKET, Intake Manifold to Cylinder Head**

4 Cyl : CJ, 1980-82 use J8132319  
 4 Cyl : CJ, 1983 use J8134694  
 4 Cyl : CJ, 1984-86 use J3242854  
 4 Cyl : Wr, 1987-89 use J3242854

6 Cyl : CJ, 1979-80 use J3183945  
 6 Cyl : CJ, 1981-86 use J3237775  
 6 Cyl : Wr, 1987-89 use J3242854

8 Cyl : CJ, 1979-81 use J8125869<sup>1</sup>

**NOTE:**

1. THIS IS A COMPLETE SET, WITH SEALS.

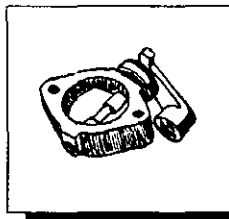

1.067

**DAMPER, Exhaust Manifold**

6 Cyl : CJ, 1979-80 use J8125076<sup>1</sup>

8 Cyl : CJ, 1979-80 use J3225005  
 8 Cyl : CJ, 1981 use J3238998

**NOTE:**

1. THIS IS A DAMPER KIT.

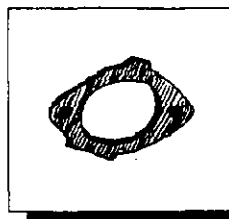

1.067

**GASKET, Exhaust Manifold Damper**

8 Cyl : CJ, 1979-81 use J5353073

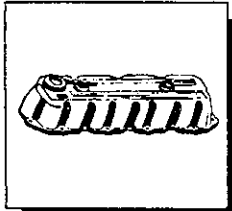

1.068

**COVER, Cylinder Head**

4 Cyl : CJ, 1980-83 use J8132236<sup>1</sup>  
 4 Cyl : CJ, 1984-86 use J3242121  
 4 Cyl : Wr, 1987-89 use 33003857

6 Cyl : CJ, 1979 use J3231912  
 6 Cyl : CJ, 1980 use J3236706  
 6 Cyl : CJ, 1981-84 use 83501398<sup>2</sup>  
 6 Cyl : CJ, 1985-86 use 33002393<sup>3</sup>  
 6 Cyl : Wr, 1987-89 use 33002393<sup>3</sup>

8 Cyl : CJ, 1979-81 use J3233719

**NOTE:**

1. 1983, FOR AMC ENGINE USE J3242121.
2. 1984, ON ENGINES W/ 5 CYLINDER HEAD COVER BOLTS USE 33002393.
3. WITH 2 NUTS. W/ 4 NUTS USE 33003691.

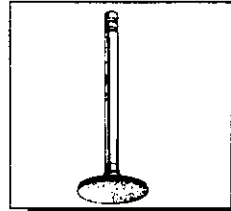

1.077

**VALVE, Intake - .003**

4 Cyl : CJ, 1980-81 use J8132228  
 4 Cyl : CJ, 1982-83 use J8134390<sup>2</sup>  
 4 Cyl : CJ, 1984-86 use J3242670  
 4 Cyl : Wr, 1987-89 use J3242670<sup>1</sup>

6 Cyl : CJ, 1979-80 use J3218809  
 6 Cyl : CJ, 1981-86 use J3240166  
 6 Cyl : Wr, 1987-89 use J3240166

**NOTE:**

1. FOR VALVE MARKED "19" USE 33003519.
2. 1983, FOR AMC ENGINE USE J3242670.

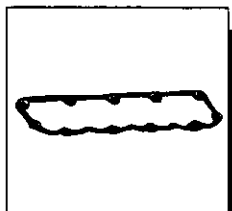

1.072

**GASKET, Cylinder Head Cover**

4 Cyl : CJ, 1980-83 use J8132811<sup>2</sup>  
 4 Cyl : CJ, 1984-86 use J3241731<sup>2</sup>  
 4 Cyl : Wr, 1987-89 use J3241731

6 Cyl : CJ, 1979-80 use J3227854  
 6 Cyl : CJ, 1981-84 use J8053050  
 6 Cyl : CJ, 1985-86 use J8993317<sup>1</sup>  
 6 Cyl : Wr, 1987-89 use J8993317<sup>1</sup>

8 Cyl : CJ, 1979-81 use J3181291<sup>2</sup>

**NOTE:**

1. LIQUID GASKET IN TUBE FORM.
2. FOR LIQUID GASKET USE J8993317.

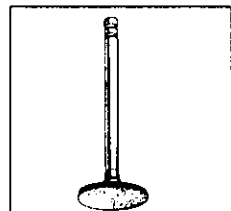

1.077

**VALVE, Intake - .015**

4 Cyl : CJ, 1980-81 use J8132443  
 4 Cyl : CJ, 1982-83 use J8134391<sup>2</sup>  
 4 Cyl : CJ, 1984-86 use J3242671  
 4 Cyl : Wr, 1987-89 use J3242671<sup>1</sup>

6 Cyl : CJ, 1979-80 use J3218810  
 6 Cyl : CJ, 1981-86 use J3240167  
 6 Cyl : Wr, 1987-89 use J3240167

**NOTE:**

1. FOR VALVE MARKED "75" USE 33003575.
2. 1983, FOR AMC ENGINE USE J3242671.

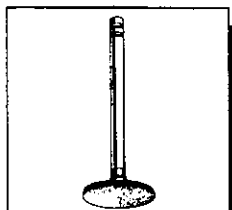

1.077

**VALVE, Intake - STD**

4 Cyl : CJ, 1980-81 use J8132227  
 4 Cyl : CJ, 1982-83 use J8134389<sup>2</sup>  
 4 Cyl : CJ, 1984-86 use J3242659  
 4 Cyl : Wr, 1987-89 use J3242659<sup>1</sup>

6 Cyl : CJ, 1979-80 use J3218732  
 6 Cyl : CJ, 1981-86 use J3237465  
 6 Cyl : Wr, 1987-89 use J3240768

8 Cyl : CJ, 1979-80 use J3218732  
 8 Cyl : CJ, 1981 use J3237465

**NOTE:**

1. FOR VALVE MARKED "15" USE 33003515.
2. 1983, FOR AMC ENGINE USE J3242659.

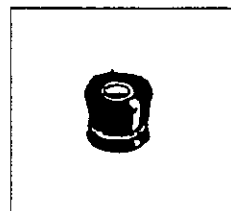

1.077

**SEAL, Intake Valve (Deflector) - STD**

4 Cyl : CJ, 1980-82 use J8133753  
 4 Cyl : CJ, 1983 use J3242864<sup>1</sup>  
 4 Cyl : CJ, 1984-86 use J3242891  
 4 Cyl : Wr, 1987-89 use 33002729

6 Cyl : CJ, 1979-86 use J3205878  
 6 Cyl : Wr, 1987-89 use J3218976

8 Cyl : CJ, 1979-81 use J3218976

**NOTE:**

1. FOR AMC ENGINE USE J3242891.

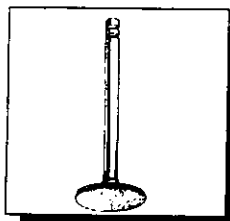

**1.078**

**VALVE, Exhaust - STD**

4 Cyl : CJ, 1980-81 use J8132229  
 4 Cyl : CJ, 1982-83 use J8134392  
 4 Cyl : CJ, 1984-85 use J3242896  
 4 Cyl : CJ, 1986 use 33002429  
 4 Cyl : Wr, 1987-89 use 33002429

6 Cyl : CJ, 1979-80 use J3223969  
 6 Cyl : CJ, 1981-86 use J3237464  
 6 Cyl : Wr, 1987-89 use J3240767

8 Cyl : CJ, 1979-80 use J3224597  
 8 Cyl : CJ, 1981 use J3237464

**NOTE:**

1. 1983, FOR AMC ENGINE USE J3242660.
2. WITHOUT VALVE ROTORS USE J3224597.
3. FOR VALVE MARKED "60" USE 33003860.

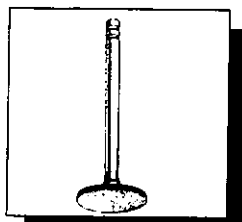

**1.078**

**VALVE, Exhaust - .003**

4 Cyl : CJ, 1980-81 use J8132230  
 4 Cyl : CJ, 1982-83 use J8134393  
 4 Cyl : CJ, 1984-85 use J3242673  
 4 Cyl : CJ, 1986 use 83502491  
 4 Cyl : Wr, 1987-89 use 83502491

6 Cyl : CJ, 1979-80 use J3223977  
 6 Cyl : CJ, 1981-86 use J3240163  
 6 Cyl : Wr, 1987-89 use J3240163

- NOTE:** 1. WITH AMC ENGINE USE J3242673.  
 2. FOR VALVE MARKED "20" USE 33003520.  
 3. WITHOUT VALVE ROTORS USE J3224602.

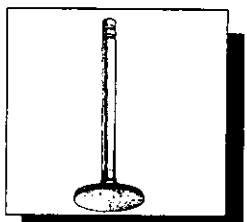

**1.078**

**VALVE, Exhaust - .015**

4 Cyl : CJ, 1980-81 use J8132444  
 4 Cyl : CJ, 1982-83 use J8134394  
 4 Cyl : CJ, 1984-85 use J3242674  
 4 Cyl : CJ, 1986 use 83502492  
 4 Cyl : Wr, 1987-89 use 83502492

6 Cyl : CJ, 1979-80 use J3223978  
 6 Cyl : CJ, 1981-86 use J3240164  
 6 Cyl : Wr, 1987-89 use J3240164

- NOTE:** 1. FOR .13 MM.  
 2. FOR VALVE MARKED "76" USE 33003576.  
 3. WITHOUT VALVE ROTORS USE J3224603.  
 4. WITH AMC ENGINE USE J3242674.

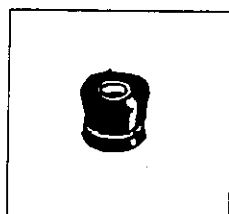

**1.078**

**SEAL, Exhaust Valve (Deflector) - STD**

4 Cyl : CJ, 1980-83 use J8132233  
 4 Cyl : CJ, 1984-86 use J3242864  
 4 Cyl : Wr, 1987-89 use 33002522

6 Cyl : CJ, 1979-86 use J3205878  
 6 Cyl : Wr, 1987-89 use J3218976

8 Cyl : CJ, 1979-81 use J3218976

**NOTE:** 1. WITH AMC ENGINE USE J3242864.

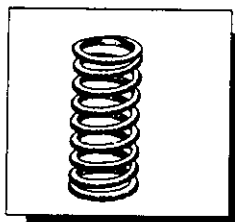

**1.083**

**SPRING, Valve**

4 Cyl : CJ, 1980-83 use J8132232  
 4 Cyl : CJ, 1984-86 use J3242678  
 4 Cyl : Wr, 1987 use J3242678  
 4 Cyl : Wr, 1988-89 use 33004296

6 Cyl : CJ, 1979-86 use J3228192  
 6 Cyl : Wr, 1987-89 use J3228192

8 Cyl : CJ, 1979-81 use J3228192

**NOTE:** 1. WITH AMC ENGINE USE J3242678.



**1.085**

**LOCK, Valve Spring Retainer (Keeper)**

4 Cyl : CJ, 1980-81 use J8132235  
 4 Cyl : CJ, 1982-83 use J8132931  
 4 Cyl : CJ, 1984-86 use J3242664  
 4 Cyl : Wr, 1987 use J3242664  
 4 Cyl : Wr, 1988-89 use 33003521

6 Cyl : CJ, 1979-80 use J3156157  
 6 Cyl : CJ, 1981-86 use J3180458  
 6 Cyl : Wr, 1987-89 use J3180458

8 Cyl : CJ, 1979-80 use J3156157  
 8 Cyl : CJ, 1981 use J3180458

**NOTE:** 1. WITH AMC ENGINE USE J3242664.

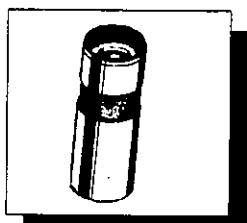

**1.088**

**TAPPET, Valve (w/ Snap Ring)**

4 Cyl : CJ, 1980-83 use J8132248  
 4 Cyl : CJ, 1984-86 use J3189883  
 4 Cyl : Wr, 1987-89 use J3222276

6 Cyl : CJ, 1979-86 use J3189883  
 6 Cyl : Wr, 1987-89 use J3222276

8 Cyl : CJ, 1979-81 use J3189883

**NOTE:** 1. WITH AMC ENGINE USE J3189883.



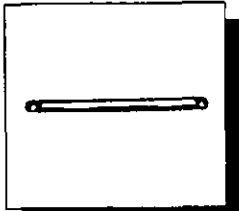

1.095

**ROD, Valve Push**

4 Cyl : CJ, 1980-81 use J8132237  
 4 Cyl : CJ, 1982 use J8134133  
 4 Cyl : CJ, 1983-86 use J3241709  
 4 Cyl : Wr, 1987-89 use J3241709

6 Cyl : CJ, 1979-80 use J3227329  
 6 Cyl : CJ, 1981-86 use J3242395  
 6 Cyl : Wr, 1987-88 use J3242395  
 6 Cyl : Wr, 1989 use 33004853

8 Cyl : CJ, 1979-81 use J3214014

**NOTE:**

1. WITH AMC ENGINE USE J3241709.



1.097

**ARM, Valve Rocker**

4 Cyl : CJ, 1980 use J8132447  
 4 Cyl : CJ, 1981-82 use J8132770  
 4 Cyl : CJ, 1983-86 use J3242393  
 4 Cyl : Wr, 1987-89 use J3242393

6 Cyl : CJ, 1979-82 use J3223888  
 6 Cyl : CJ, 1983-86 use J3242393  
 6 Cyl : Wr, 1987-89 use J3242393

8 Cyl : CJ, 1979-81 use J3223539

**NOTE:** 1. WITH AMC ENGINE USE J3242393.

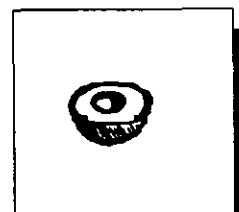

1.099

**BALL, Rocker Arm**

4 Cyl : CJ, 1980 use J8132239  
 4 Cyl : CJ, 1981-83 use J8132771

**NOTE:** 1. FOR 1983, USED WITH GM ENGINE.

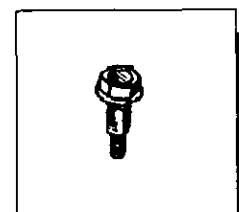

1.100

**BOLT, Valve Rocker Arm Ball**

4 Cyl : CJ, 1980 use J8132240  
 4 Cyl : CJ, 1981-83 use J8132772

**NOTE:** 1. FOR 1983, USED WITH GM ENGINE.

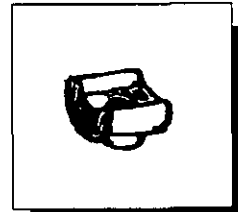

1.101

**PIVOT, Valve Rocker Arm**

4 Cyl : CJ, 1983-86 use J3235090  
 4 Cyl : Wr, 1987-89 use J3235090

6 Cyl : CJ, 1979 use J3210178  
 6 Cyl : CJ, 1980-86 use J3235090  
 6 Cyl : Wr, 1987-89 use J3235090

8 Cyl : CJ, 1979 use J3210178  
 8 Cyl : CJ, 1980-81 use J3235090

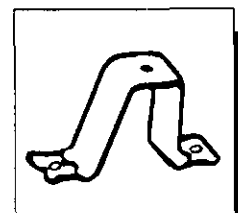

1.101

**BRIDGE, Rocker Arm**

4 Cyl : CJ, 1983-86 use J3236513  
 4 Cyl : Wr, 1987-89 use J3236513

6 Cyl : CJ, 1980-86 use J3236513  
 6 Cyl : CJ, 1987-89 use J3236513

8 Cyl : CJ, 1980-81 use J3236513

**NOTE:** 1. 1981-86, INCLUDING COVER STUD USE J3237851.

2. FOR PIVOT & BRIDGE KIT USE 3236513K.

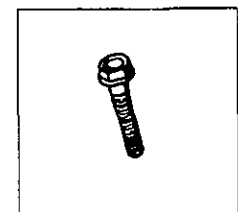

1.101

**BOLT, Pivot to Cylinder Head**

4 Cyl : CJ, 1983-86 use J8120512  
 4 Cyl : Wr, 1987-89 use J8120512

6 Cyl : CJ, 1979-86 use J8120512  
 6 Cyl : Wr, 1987-89 use J8120512

8 Cyl : CJ, 1979-81 use J8120512

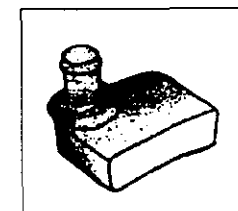

1.116

**FILTER, Cylinder Head Cover to Air Cleaner Hose**

4 Cyl : CJ, 1981-86 use J3236695

6 Cyl : CJ, 1979 use J3224380  
 6 Cyl : CJ, 1980-86 use J3236695  
 6 Cyl : Wr, 1987-89 use J3236695

8 Cyl : CJ, 1981 use J3236695

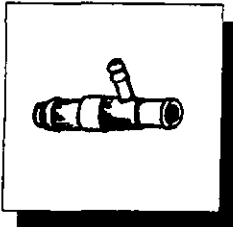

1.119

**VALVE, PCV**

4 Cyl : CJ, 1980-83 use J8132309<sup>1</sup>  
 4 Cyl : CJ, 1984-86 use 33001239  
 4 Cyl : Wr, 1987-89 use 33001239

6 Cyl : CJ, 1979 use J3232845  
 6 Cyl : CJ, 1980 use J3236680  
 6 Cyl : CJ, 1981 use J3240359  
 6 Cyl : CJ, 1982-86 use J3241629<sup>2</sup>  
 6 Cyl : Wr, 1987-89 use J3239068

8 Cyl : CJ, 1979-81 use J3234216

**NOTE:**

1. 1983, FOR AMC ENGINE USE 33001239.
2. FOR 1983-86, WITH VALVE & ELBOW USE 33000887.

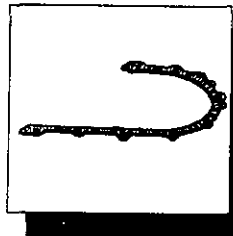

1.121

**GASKET, Timing Case Cover**

4 Cyl : CJ, 1980-81 use J8132220  
 4 Cyl : CJ, 1982-83 use J8133747<sup>1</sup>  
 4 Cyl : CJ, 1984-86 use J3225187  
 4 Cyl : Wr, 1987-89 use J3225187

6 Cyl : CJ, 1979-86 use J3225187  
 6 Cyl : Wr, 1987-89 use J3225187

8 Cyl : CJ, 1979-81 use J3180216

**NOTE:**

1. FOR 1983, FOR AMC ENGINE USE J3225187.

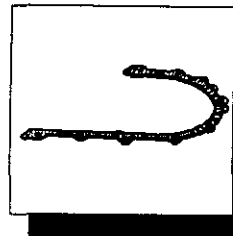

1.121

**GASKET SET, Timing Case Cover**

4 Cyl : CJ, 1983-86 use J8129097<sup>1</sup>  
 4 Cyl : Wr, 1987-89 use J8129097

6 Cyl : CJ, 1979-86 use J8129097  
 6 Cyl : Wr, 1987-89 use J8129097

8 Cyl : CJ, 1979-81 use J8129098

**NOTE:** 1. APPLIES TO AMC ENGINE.



1.119

**GROMMET, Cylinder Head Cover**

4 Cyl : CJ, 1980-81 use J8132210  
 4 Cyl : CJ, 1982-83 use J8134400<sup>1,2</sup>  
 4 Cyl : CJ, 1984-86 use J3237765<sup>2</sup>  
 4 Cyl : Wr, 1987-89 use 33001237

6 Cyl : CJ, 1979-80 use J3225627  
 6 Cyl : CJ, 1981-86 use J3237765  
 6 Cyl : Wr, 1987-89 use J3237765

**NOTE:**

1. FOR 1983, FOR AMC ENGINE USE J3237765.
2. FOR .72" INSIDE DIAMETER. FOR .45" INSIDE DIAMETER USE 33001237.

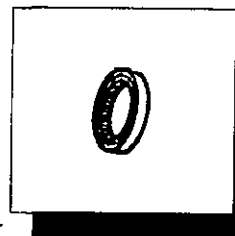

1.123

**SEAL, Timing Case Cover**

4 Cyl : CJ, 1980-81 use J8132221  
 4 Cyl : CJ, 1982-83 use J8133748<sup>1</sup>  
 4 Cyl : CJ, 1984-86 use J3224704  
 4 Cyl : Wr, 1987 use J3224704  
 4 Cyl : Wr, 1988-89 use 33004681

6 Cyl : CJ, 1979-86 use J3224704  
 6 Cyl : Wr, 1987 use J3224704  
 6 Cyl : Wr, 1988-89 use 33004681

8 Cyl : CJ, 1979-81 use J3193613

**NOTE:** 1. FOR AMC ENGINE USE J3224704

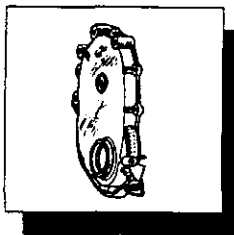

1.120

**COVER ASSY, Timing Case**

4 Cyl : CJ, 1980-83 use J8132219<sup>1</sup>  
 4 Cyl : CJ, 1984-86 use J3243096  
 4 Cyl : Wr, 1987-89 use 83505398

6 Cyl : CJ, 1979-86 use J3225186  
 6 Cyl : Wr, 1987-89 use 83505398

8 Cyl : CJ, 1979-81 use J8129373

**NOTE:**

1. FOR 1983, FOR AMC ENGINE USE J3243096.

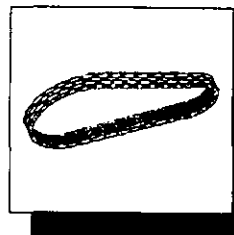

1.130

**CHAIN, Timing**

4 Cyl : CJ, 1983-86 use J3242300<sup>1</sup>  
 4 Cyl : Wr, 1987-89 use J3242300

6 Cyl : CJ, 1979-86 use J3172307  
 6 Cyl : Wr, 1987-89 use J3240502

8 Cyl : CJ, 1979-81 use J3234433<sup>2</sup>

**NOTE:** 1. APPLIES TO AMC ENGINE.

2. FOR 1979, WHERE WIDTH OF TEETH ON CAM-SHAFT AND CRANKSHAFT SPROCKETS IS 5/8" USE J3185270.

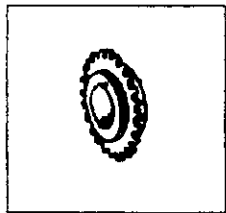

**1.132**

**SPROCKET, Crankshaft**

4 Cyl : CJ, 1980-83 use J8132270  
 4 Cyl : CJ, 1984-86 use J3242281  
 4 Cyl : Wr, 1987-89 use J3242281

6 Cyl : CJ, 1979-86 use J3173205  
 6 Cyl : Wr, 1987-89 use 33004107

8 Cyl : CJ, 1979-81 use J3234235

**NOTE:**

1. FOR 1983, FOR AMC ENGINE USE J3242281.
2. FOR 1979, WHERE WIDTH OF TEETH IS 5/8" USE J3223199.

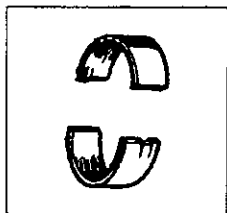

**1.138**

**BEARING, Connecting Rod - STD**  
 (with Upper and Lower)

4 Cyl : CJ, 1980-83 use J8132255  
 4 Cyl : CJ, 1984-86 use 83500300  
 4 Cyl : Wr, 1987-89 use 83500300

6 Cyl : CJ, 1979-86 use J8126204  
 6 Cyl : Wr, 1987-89 use J8126204

8 Cyl : CJ, 1979-81 use J8126204

**NOTE:** 1. 1983, FOR AMC ENGINE USE 83500300.

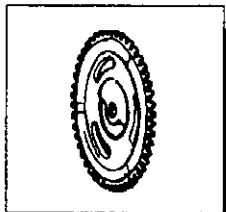

**1.134**

**SPROCKET, Camshaft**

4 Cyl : CJ, 1980-83 use J8132271  
 4 Cyl : CJ, 1984-86 use J3242280  
 4 Cyl : Wr, 1987-89 use J3242280

6 Cyl : CJ, 1979-86 use J3206693  
 6 Cyl : Wr, 1987-89 use J3172306

8 Cyl : CJ, 1979-81 use J3234234

**NOTE:**

1. 1983, FOR AMC ENGINE USE J3242280.
2. 1979, FOR WIDTH OF TEETH OF 5/8" USE J3197138.

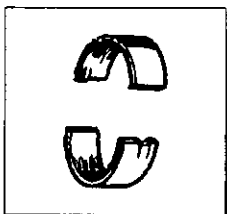

**1.138**

**BEARING, Connecting Rod - .001**  
 (with Upper and Lower)

4 Cyl : CJ, 1981-83 use J8133438  
 4 Cyl : CJ, 1984-86 use 83501397  
 4 Cyl : Wr, 1987-89 use 83501397

6 Cyl : CJ, 1979-86 use J8126205  
 6 Cyl : Wr, 1987-89 use J8126205

8 Cyl : CJ, 1979-81 use J8126205

**NOTE:** 1. 1983, FOR AMC ENGINE USE 83501397.

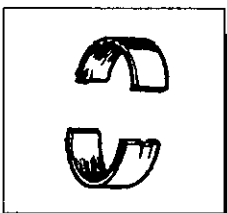

**1.138**

**BEARING, Connecting Rod - .002**  
 (with Upper and Lower)

4 Cyl : CJ, 1981-83 use J8133439

6 Cyl : CJ, 1979-86 use J8126206  
 6 Cyl : Wr, 1987-89 use J8126206

8 Cyl : CJ, 1979-81 use J8126206

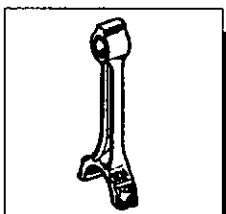

**1.136**

**ROD ASSY, Connecting**

4 Cyl : CJ, 1980-83 use J8132253  
 4 Cyl : CJ, 1984-86 use J3237816  
 4 Cyl : Wr, 1987-89 use 33004545

6 Cyl : CJ, 1979-81 use J3180444  
 6 Cyl : CJ, 1982-86 use J3237812  
 6 Cyl : Wr, 1987-89 use J3237812

8 Cyl : CJ, 1979-81 use J3196750

**NOTE:**

1. 1983, FOR AMC ENGINE USE J3237816.
2. THRU 1982 w/ I.D. CASTING #707.

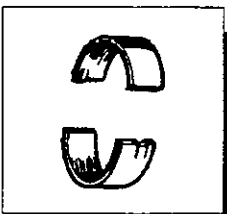

**1.138**

**BEARING, Connecting Rod - .010**  
 (with Upper and Lower)

4 Cyl : CJ, 1980-83 use J8132254  
 4 Cyl : CJ, 1984-86 use 83500301  
 4 Cyl : Wr, 1987-89 use 83500301

6 Cyl : CJ, 1979-86 use J8126207  
 6 Cyl : Wr, 1987-89 use J8126207

8 Cyl : CJ, 1979-81 use J8126207

**NOTE:**

1. 1983, FOR AMC ENGINE USE 83500301.

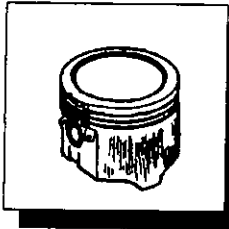

**1.143**

**PISTON, With Pin - STD**

4 Cyl : CJ, 1980-81 use J8132448<sup>1</sup>  
 4 Cyl : CJ, 1982-83 use J8134136<sup>2</sup>  
 4 Cyl : CJ, 1984-86 use 83500251  
 4 Cyl : Wr, 1987-89 use 83500251

6 Cyl : CJ, 1979-82 use J8130208  
 6 Cyl : CJ, 1983-86 use J8134441  
 6 Cyl : Wr, 1987-89 use J8134441

8 Cyl : CJ, 1979-81 use J4487564

NOTE: 1. FOR 1981, PISTON I.D. CASTING #10016666 ON SKIRT USE J8133673.  
 2. 1983, FOR AMC ENGINE USE 83500251.

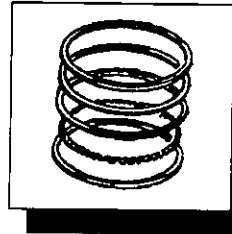

**1.146**

**RING SET, Piston (Engine) - .010**

6 Cyl : CJ, 1979-86 use J8121684  
 6 Cyl : Wr, 1987-89 use J8121684

8 Cyl : CJ, 1979-81 use J8121685

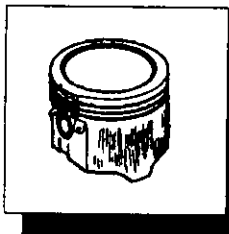

**1.143**

**PISTON, With Pin - .010**

4 Cyl : CJ, 1980-81 use J8132449<sup>1</sup>  
 4 Cyl : CJ, 1982-83 use J8134137<sup>2</sup>  
 4 Cyl : CJ, 1984-86 use 83500252  
 4 Cyl : Wr, 1987-89 use 83500252

6 Cyl : CJ, 1979-81 use J8132885  
 6 Cyl : CJ, 1982-86 use J8134442  
 6 Cyl : Wr, 1987-89 use J8134442

8 Cyl : CJ, 1979-81 use J4487565

NOTE: 1. FOR 1981, PISTON I.D. CASTING #10016666 ON SKIRT USE J8133674.  
 2. 1983, FOR AMC ENGINE USE 83500252.

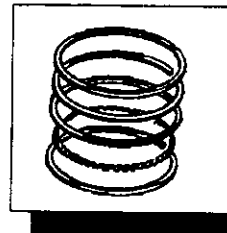

**1.146**

**RINGS, Piston - STD**

Single Piston

4 Cyl : CJ, 1980-81 use J8132451<sup>1</sup>  
 4 Cyl : CJ, 1982-83 use J8134140<sup>2</sup>  
 4 Cyl : CJ, 1984-86 use 83500210  
 4 Cyl : Wr, 1987-89 use 83500210

NOTE: 1. 1981, PISTON I.D. CASTING #10016666 USE J8133406.  
 2. 1983, FOR AMC ENGINE USE 83500210.

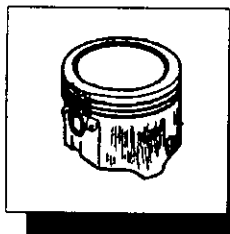

**1.143**

**PISTON, With Pin -.030**

4 Cyl : CJ, 1980-81 use J8132450<sup>1</sup>  
 4 Cyl : CJ, 1982-83 use J8134138<sup>2</sup>

NOTE:

1. FOR 1981, PISTON I.D. CASTING #10016671 USE J8133675.  
 2. FOR GM ENGINE ONLY.

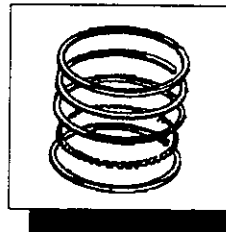

**1.146**

**RINGS, Piston - .010**

Single Piston

4 Cyl : CJ, 1980-81 use J8132452<sup>1</sup>  
 4 Cyl : CJ, 1982-83 use J8134142<sup>2</sup>  
 4 Cyl : CJ, 1984-86 use 83500211  
 4 Cyl : Wr, 1987-89 use 83500211

NOTE: 1. 1981, PISTON I.D. CASTING #10016666 USE J8133408.  
 2. 1983, FOR AMC ENGINE USE 83500211.

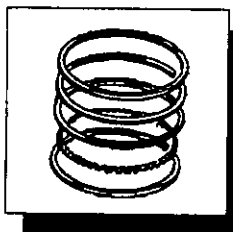

**1.146**

**RING SET, Piston (Engine) - STD**

6 Cyl : CJ, 1979-86 use J8121683  
 6 Cyl : Wr, 1987-89 use J8121683

8 Cyl : CJ, 1979-81 use J8121685

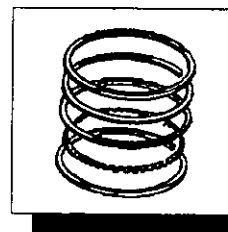

**1.146**

**RINGS, Piston - .030**

Single Piston

4 Cyl : CJ, 1980-81 use J8132453<sup>1</sup>  
 4 Cyl : CJ, 1982-83 use J8134143<sup>2</sup>

NOTE:

1. 1981, PISTON I.D. CASTING #10016671 USE J8133409.  
 2. FOR GM ENGINE ONLY.

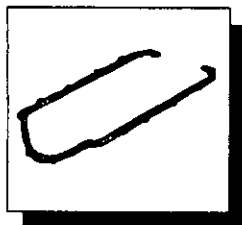

1.152

**GASKET SET, Engine Oil Pan**

4 Cyl : CJ, 1980-81 use J8132290  
 4 Cyl : CJ, 1982-83 use J8133754  
 4 Cyl : CJ, 1984-86 use 83500270  
 4 Cyl : Wr, 1987 use 83500270  
 4 Cyl : Wr, 1988-89 use 83504661

6 Cyl : CJ, 1979-86 use J4888770  
 6 Cyl : Wr, 1987 use J4488770  
 6 Cyl : Wr, 1988-89 use 83504662

8 Cyl : CJ, 1979-81 use J3206690

NOTE: 1. WITH AMC ENGINE USE 83500270.

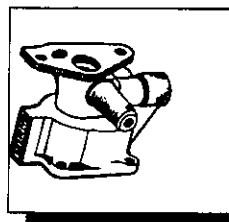

1.154

**PUMP ASSY, Engine Oil**

4 Cyl : CJ, 1980-83 use J8132303<sup>1</sup>  
 4 Cyl : CJ, 1984-86 use J3241602  
 4 Cyl : Wr, 1987-89 use J3243102

6 Cyl : CJ, 1979-80 use J3181340  
 6 Cyl : CJ, 1981-82 use J3238637<sup>2</sup>  
 6 Cyl : CJ, 1983-86 use J3242141<sup>3</sup>  
 6 Cyl : Wr, 1987-89 use J3242141

8 Cyl : CJ, 1979-81 use 3184086K<sup>4</sup>

**NOTE:**

1. WITH AMC ENGINE USE J3241602.
2. OIL PUMP COVER HAS 4 MOUNTING HOLES - NO TAB.
3. COVER HAS 4 MOUNTING HOLES - TAB WITH SLOTTED HOLE.
4. REPAIR KIT ONLY. FOR COVER USE J3226242

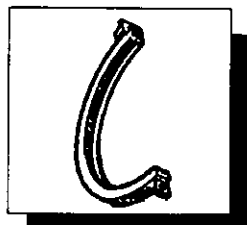

1.152

**SEAL, Engine Oil Pan to Bearing Cap**

4 Cyl : CJ, 1981 use J8133412  
 4 Cyl : CJ, 1982-83 use J8134149<sup>1</sup>  
 4 Cyl : CJ, 1984-86 use J3241609  
 4 Cyl : Wr, 1987-89 use J3241609

6 Cyl : CJ, 1979-86 use J3177635  
 6 Cyl : Wr, 1987 use J3177635  
 6 Cyl : Wr, 1988-89 use 33004733

8 Cyl : CJ, 1979-81 use J3177635

NOTE: 1. WITH AMC ENGINE USE J3241609.

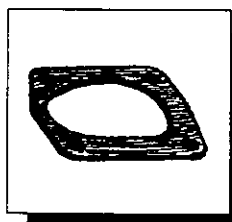

1.165

**GASKET, Engine Oil Pump Cover**

4 Cyl : CJ, 1980-83 use J8132307  
 4 Cyl : CJ, 1983-86 use J3172332<sup>1</sup>  
 4 Cyl : Wr, 1987-89 use J3172332

6 Cyl : CJ, 1979-86 use J3172332<sup>3</sup>  
 6 Cyl : CJ, 1979-86 use J3172337<sup>2</sup>  
 6 Cyl : Wr, 1987-89 use J3172332

8 Cyl : CJ, 1979-81 use J3226241

**NOTE:**

1. WITH AMC ENGINE ONLY.
2. COVER GASKET.
3. OIL PUMP TO CYLINDER BLOCK.

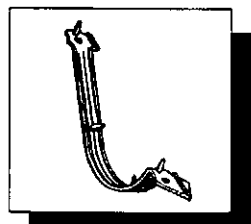

1.154

**SEAL, Oil Pan Timing Case Cover**

4 Cyl : CJ, 1980-83 use J8132286<sup>1</sup>  
 4 Cyl : CJ, 1984-86 use J3172848  
 4 Cyl : Wr, 1987 use J3172848  
 4 Cyl : Wr, 1988-89 use 83504654

6 Cyl : CJ, 1979-86 use J3172848  
 6 Cyl : Wr, 1987 use J3172848  
 6 Cyl : Wr, 1988-89 use 83504654

8 Cyl : CJ, 1979-81 use J3180414

NOTE: 1. WITH AMC ENGINE USE J3172848.

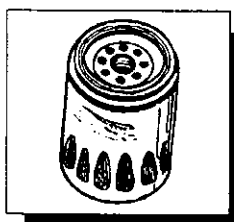

1.206

**ELEMENT, Oil Filter**

4 Cyl : CJ, 1980-86 use J8132313  
 4 Cyl : Wr, 1987 use 33003509  
 4 Cyl : Wr, 1988-89 use 33004195

6 Cyl : CJ, 1979-82 use J8993146  
 6 Cyl : CJ, 1983-86 use J3242397  
 6 Cyl : Wr, 1987 use 33003509  
 6 Cyl : Wr, 1988-89 use 33004195

8 Cyl : CJ, 1979-81 use J8993146

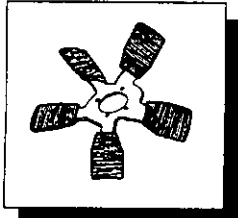

2.002

**BLADES**, Fan (Radiator) - 4 Blades  
W/O H.D.C. ; W/O S.B.D.

4 Cyl : CJ, 1980-83 use J3236604  
6 Cyl : CJ, 1979-86 use J3224499  
8 Cyl : CJ, 1979-81 use J998760

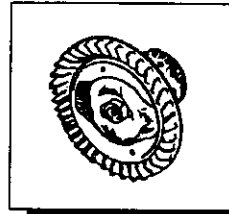

2.004

**TEMPATROL**, Fan Drive Clutch

4 Cyl : CJ, 1980 use J3236603  
4 Cyl : CJ, 1981 use J3239377  
4 Cyl : CJ, 1982-83 use J3241856<sup>2</sup>  
4 Cyl : CJ, 1983-86 use J3241857  
4 Cyl : Wr, 1987-89 use J3241857

6 Cyl : CJ, 1981-86 use J5362170  
6 Cyl : Wr, 1987-89 use J3241857<sup>1</sup>

8 Cyl : CJ, 1979-81 use J5362722

NOTE: 1. WITH S.B.D. USE J3241858.  
2. WITH AMC ENGINE USE J3241857.

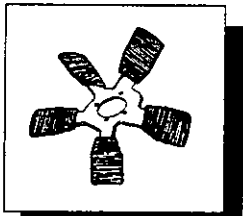

2.002

**BLADES**, Fan (Radiator) - 5 Blades

4 Cyl : CJ, 1981-83 use J3236530<sup>1</sup>  
4 Cyl : CJ, 1983-86 use 33001061  
4 Cyl : Wr, 1987-89 use 52001965  
6 Cyl : Wr, 1987-89 use J3237182<sup>2</sup>

NOTE:  
1. WITH AMC ENGINE USE 33001061.  
2. WITH SERPENTINE BELT DRIVE USE J3239446.

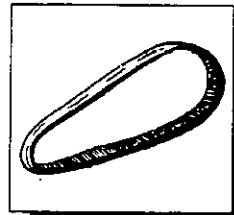

2.015

**BELT**, Serpentine Drive  
W/ A.C. ; W/ P.S.

6 Cyl : CJ, 1981 use J3239591  
6 Cyl : CJ, 1982 use J3241096  
6 Cyl : CJ, 1983-86 use J3239594  
6 Cyl : Wr, 1987-89 use 53001120

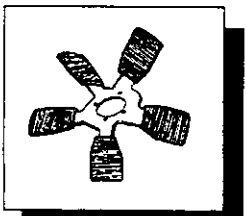

2.002

**BLADES**, Fan (Radiator) - 7 Blades  
W/ H.D.C. ; W/O S.B.D.

4 Cyl : CJ, 1980-83 use J3236530  
6 Cyl : CJ, 1981-86 use J0994277  
8 Cyl : CJ, 1981 use J0994277

NOTE:  
1. WITHOUT TEMPATROL USE J5357390. NON-FLEXIBLE.

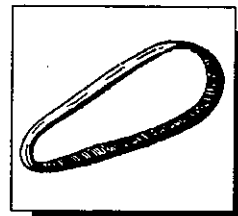

2.015

**BELT**, Serpentine Drive  
W/O A.C. ; W/O P.S.

6 Cyl : CJ, 1981-82 use J3239594<sup>1</sup>  
6 Cyl : CJ, 1983-86 use 33000558  
6 Cyl : Wr, 1987-89 use 53001119

NOTE:  
1. W/O A.C., WITH P.S. USE J3239595.

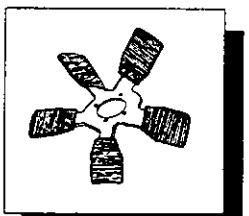

2.002

**BLADES**, Fan (Radiator) - 7 Blades  
W/ H.D.C. ; W/ S.B.D.

6 Cyl : CJ, 1981-86 use J5362528

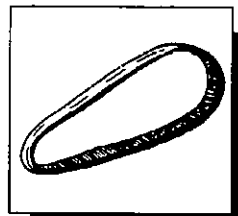

2.016

**BELT**, Radiator Fan  
W/O A.C. ; To Alternator

4 Cyl : CJ, 1981-82 use J3239606<sup>1</sup>  
4 Cyl : CJ, 1983-86 use J3239615<sup>2</sup>  
4 Cyl : Wr, 1987-89 use J3239615<sup>2</sup>

6 Cyl : CJ, 1979-80 use J3223006  
6 Cyl : CJ, 1981-86 use J3239615<sup>3</sup>  
6 Cyl : Wr, 1987-89 use J3239615<sup>2</sup>

8 Cyl : CJ, 1979-81 use J3227690<sup>4</sup>

NOTE:  
1. TO POWER STEERING PUMP USE G9433651.  
2. TO POWER STEERING PUMP USE J3226936.  
3. TO IDLER USE J3225356. W/ A.C. TO POWER STEERING PUMP OR EMISSION PUMP USE J3226936.  
4. TO POWER STEERING PUMP USE J3227692.

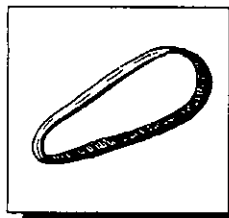

**2.016**

**BELT SET, Radiator Fan**  
W/ A.C. ; 56 - 66 AMP

8 Cyl : CJ, 1979-81 use J3227691

**NOTE:**

1. FOR 70-85 AMP, W/A.C. USE J5362180.  
FOR 70-85 AMP, W/O A.C. USE J5362181.

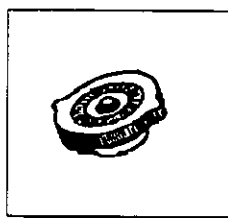

**2.032**

**CAP, Radiator Core**  
With Coolant Recovery

4 Cyl : CJ, 1980-86 use J5358177  
4 Cyl : Wr, 1987-89 use J3239375

6 Cyl : CJ, 1979-86 use J5358177  
6 Cyl : Wr, 1987-89 use J3239375

8 Cyl : CJ, 1979-81 use J5358177

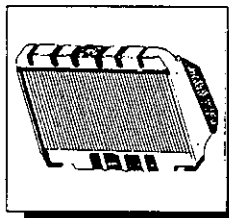

**2.020**

**RADIATOR, W/O H.D.C.**

4 Cyl : CJ, 1980-83 use J5362898  
4 Cyl : CJ, 1984-86 use J5364658  
4 Cyl : Wr, 1987-89 use 52040286

6 Cyl : CJ, 1979 use J5359004  
6 Cyl : CJ, 1980 use J5361559  
6 Cyl : CJ, 1981-86 use J5362165  
6 Cyl : Wr, 1987-89 use 52040286

8 Cyl : CJ, 1979-81 use J5361578

**NOTE:**

1. WITH AMC ENGINE USE J5364658.

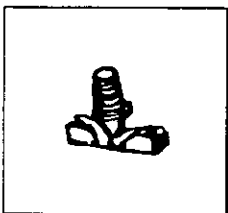

**2.036**

**DRAINCOCK, Radiator Core**

4 Cyl : CJ, 1980 use JA001126  
4 Cyl : CJ, 1983-86 use J3166547  
4 Cyl : Wr, 1987-89 use J3166547

6 Cyl : CJ, 1979-86 use JA001126  
6 Cyl : Wr, 1987-89 use 8133254

8 Cyl : CJ, 1979-81 use JA001126

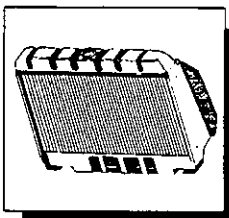

**2.020**

**RADIATOR, W/ H.D.C.**

4 Cyl : CJ, 1980-83 use J5362898  
4 Cyl : CJ, 1984-86 use J5364658

6 Cyl : CJ, 1979 use J5359004  
6 Cyl : CJ, 1980 use J5361573  
6 Cyl : CJ, 1981-86 use J5362492  
6 Cyl : Wr, 1987-89 use 52040288

8 Cyl : CJ, 1979-81 use J5361574

**NOTE:**

1. WITH AMC ENGINE USE J5364658.

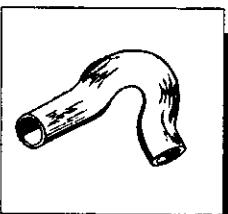

**2.038**

**HOSE, Inlet**

4 Cyl : CJ, 1980-83 use J5360950  
4 Cyl : CJ, 1984-86 use J5364659  
4 Cyl : Wr, 1987 use 52040235  
4 Cyl : Wr, 1988-89 use 52003911

6 Cyl : CJ, 1979-80 use J0999935  
6 Cyl : CJ, 1981-86 use J5362697  
6 Cyl : Wr, 1987 use 52040290  
6 Cyl : Wr, 1988-89 use 52040906

8 Cyl : CJ, 1979-81 use J0999632

**NOTE:** 1. WITH AMC ENGINE USE J5364659.



**2.032**

**CAP, Radiator Core**  
W/O Coolant Recovery

4 Cyl : CJ, 1980-86 use J5352954  
4 Cyl : Wr, 1987-89 use J3239375

6 Cyl : CJ, 1979-80 use J5352954  
6 Cyl : Wr, 1987-89 use J3239375

8 Cyl : CJ, 1979-81 use J5352954

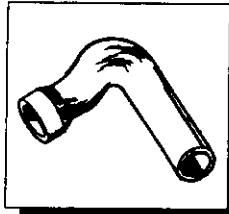

**2.038**

**HOSE, Outlet**

4 Cyl : CJ, 1980-83 use J5360951<sup>1</sup>  
 4 Cyl : CJ, 1984-86 use J5364660  
 4 Cyl : Wr, 1987 use 52040236  
 4 Cyl : Wr, 1988-89 use 52003910

6 Cyl : CJ, 1979-86 use J5354380<sup>2</sup>  
 6 Cyl : Wr, 1987 use 52040289  
 6 Cyl : Wr, 1988-89 use 52003905

8 Cyl : CJ, 1979-81 use J5354528

NOTE: 1. WITH AMC ENGINE USE J5364660.  
 2. WITH H.D.C. USE J5362162.

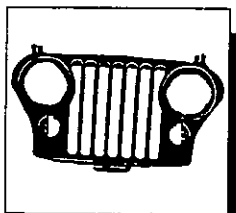

**2.050**

**GRILLE, Radiator**

4 Cyl : CJ, 1980-86 use J5752656  
 4 Cyl : Wr, 1987-89 use 55015847

6 Cyl : CJ, 1979-86 use J5752656  
 6 Cyl : Wr, 1987-89 use 55015847

8 Cyl : CJ, 1979-81 use J5752656

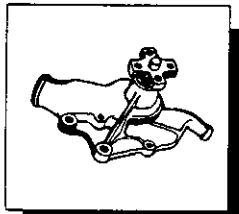

**2.080**

**WATER PUMP**

4 Cyl : CJ, 1980-83 use J8132274<sup>4</sup>  
 4 Cyl : CJ, 1983-86 use J8134320<sup>1</sup>  
 4 Cyl : Wr, 1987-89 use 83502957

6 Cyl : CJ, 1979 use J8125501  
 6 Cyl : CJ, 1980 use J8130749  
 6 Cyl : CJ, 1981-86 use J8133033<sup>2</sup>  
 6 Cyl : Wr, 1987-89 use 83502957<sup>3</sup>

8 Cyl : CJ, 1979-81 use J3234427

NOTE:

1. FOR AMC ENGINE W/ S.B.D. USE J8134321.
2. WITH S.B.D. USE J8133034.
3. WITHOUT S.B.D. WITH S.B.D. USE 83502938.
4. FOR AMC ENGINE USE J8134320.

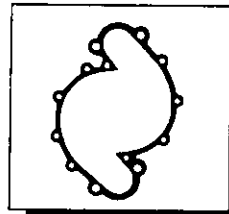

**2.098**

**GASKET, Water Pump**

4 Cyl : CJ, 1980-83 use J8132275<sup>1</sup>  
 4 Cyl : ALL, 1983-89 use J3173204

6 Cyl : ALL, 1979-89 use J3173204

8 Cyl : CJ, 1979-81 use J3181899

NOTE: 1. FOR AMC ENGINE USE J3173204.



**2.100**

**THERMOSTAT, Engine Cooling**

4 Cyl : CJ, 1980-81 use J8132280  
 4 Cyl : CJ, 1982-83 use J8134146<sup>1</sup>  
 4 Cyl : ALL, 1984-89 use 83501426

6 Cyl : CJ, 1979-82 use J8127383

6 Cyl : CJ, 1983-86 use 83500360

6 Cyl : Wr, 1987-89 use 83501426

8 Cyl : CJ, 1979-81 use J8127383

NOTE: 1. WITH AMC ENGINE USE 83501426.  
 (195)

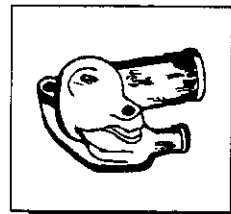

**2.102**

**HOUSING, Thermostat**

4 Cyl : CJ, 1980-81 use J8132282  
 4 Cyl : CJ, 1982-83 use J8134147<sup>1</sup>  
 4 Cyl : CJ, 1983-86 use J3235347  
 4 Cyl : Wr, 1987 use 33002929  
 4 Cyl : Wr, 1988 use 33003612  
 4 Cyl : Wr, 1989 use 83005529

6 Cyl : CJ, 1979-80 use J3224216

6 Cyl : CJ, 1981-86 use J3235347

6 Cyl : Wr, 1987 use 33002929

6 Cyl : Wr, 1988-89 use 33004856

8 Cyl : CJ, 1979-80 use J3210852

8 Cyl : CJ, 1981 use J3238509

NOTE: 1. FOR AMC ENGINE USE J3235347.

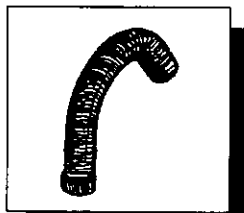

**2.080**

**HOSE, Water Pump to Thermostat Housing**

4 Cyl : Wr, 1987 use 33003581  
 4 Cyl : Wr, 1988-89 use 32002708

6 Cyl : Wr, 1987 use J3728191  
 6 Cyl : Wr, 1988-89 use 52003908

8 Cyl : CJ, 1979-81 use J3182494

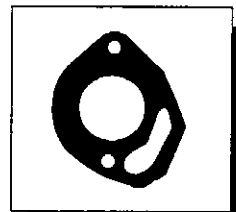

**2.102**

**GASKET, Thermostat Housing**

4 Cyl : CJ, 1980-81 use J8132582  
 4 Cyl : CJ, 1982-83 use J8134148  
 4 Cyl : ALL, 1984-89 use J3189874

6 Cyl : ALL, 1979-89 use J3189874

8 Cyl : CJ, 1979-81 use J3187543

NOTE: 1. FOR AMC ENGINE USE J3189874.



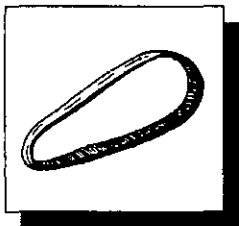

**3.008**

**BELT, Alternator & Crankshaft Pulley**  
W/O American Air ; W/O A.C.

4 Cyl : CJ, 1980 use J3236830  
4 Cyl : CJ, 1981-83 use J3239606<sup>3</sup>  
4 Cyl : CJ, 1983-86 use J3239615  
4 Cyl : Wr, 1987-89 use J3239615

6 Cyl : CJ, 1979-80 use J3223006  
6 Cyl : CJ, 1981-86 use J3239615<sup>1</sup>  
6 Cyl : Wr, 1987-89 use 52040267

8 Cyl : CJ, 1979-80 use J3227690<sup>2</sup>

**NOTE:**

1. FOR 70-85 AMP. ALTERNATOR W/O S.B.D. USE J3238269.
2. 1981, NOT FOR 70-85 AMP. ALT. SEE GROUP 2.016 "BELT SETS".
3. FOR AMC ENGINE USE J3239615.

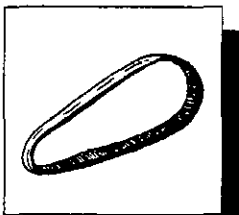

**3.008**

**BELT, Alternator & Crankshaft Pulley**  
W/O American Air ; With A.C.

4 Cyl : CJ, 1980 use J3236830  
4 Cyl : CJ, 1981-83 use J3239606

6 Cyl : CJ, 1979-80 use J3224451  
6 Cyl : CJ, 1981-86 use J3239645

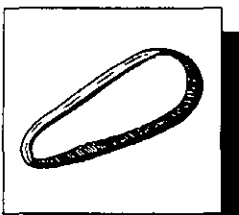

**3.008**

**BELT, Alternator & Crankshaft Pulley**  
With American Air

4 Cyl : CJ, 1980-83 use J8132878  
4 Cyl : Wr, 1987-89 use 83501923

6 Cyl : CJ, 1979-80 use J8126190  
6 Cyl : CJ, 1981-86 use J8133877  
6 Cyl : Wr, 1987-89 use 83501923

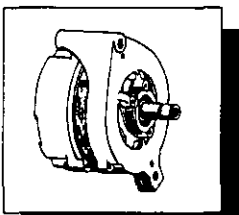

**3.016**

**ALTERNATOR, 63 AMP**  
Without Fan & Pulley

4 Cyl : CJ, 1980-82 use J8127023<sup>1</sup>  
4 Cyl : CJ, 1983-86 use J8134663

6 Cyl : CJ, 1979-80 use J8127023  
6 Cyl : CJ, 1981-86 use J8134663

8 Cyl : CJ, 1979-81 use J8127023

**NOTE:**

1. INCLUDING METRIC HARDWARE USE J8131881.

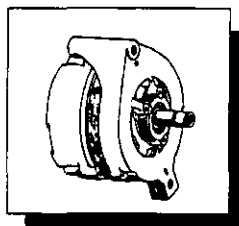

**3.016**

**ALTERNATOR, 70 AMP**  
Without Fan & Pulley

4 Cyl : CJ, 1981-82 use J8133346

6 Cyl : CJ, 1981-82 use J8133346

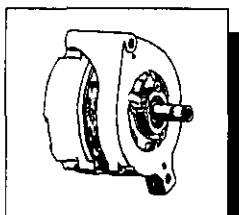

**3.016**

**ALTERNATOR, 78 AMP**  
Without Fan & Pulley (56-66-78 for YJ)

4 Cyl : CJ, 1980-82 use J8134664  
4 Cyl : Wr, 1987-89 use J8134664

6 Cyl : CJ, 1979-80 use J8134664  
6 Cyl : Wr, 1987-89 use J8134664

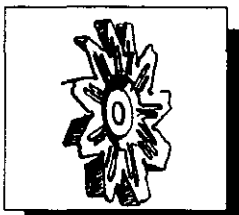

**3.017**

**FAN, Alternator - 42-55-63 AMP**  
Without American Air

4 Cyl : CJ, 1980 use J8125193<sup>1</sup>  
4 Cyl : CJ, 1981-86 use J8132695

6 Cyl : CJ, 1979-80 use J8125193<sup>1</sup>  
6 Cyl : CJ, 1981-86 use J8132695

8 Cyl : CJ, 1979-81 use J8125193<sup>1</sup>

**NOTE:**

1. WITH A.C., W/O A.C. USE J8132695

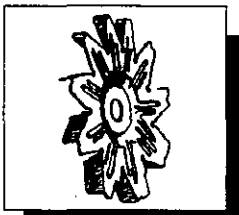

**3.017**

**FAN, Alternator - 56-66-78 AMP**  
Without American Air

4 Cyl : CJ, 1980-82 use J8134662  
4 Cyl : Wr, 1987-89 use J8134662

6 Cyl : CJ, 1979-80 use J8134662  
6 Cyl : Wr, 1987-89 use J8134662

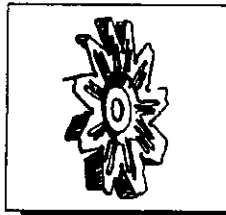

**3.017**

**FAN, Alternator - 70-85 AMP**  
W/O American Air

4 Cyl : CJ, 1980 use J8125193 †  
4 Cyl : CJ, 1981-86 use J8133281

6 Cyl : CJ, 1979-80 use J8125193 †  
6 Cyl : CJ, 1981-86 use J8133281

8 Cyl : CJ, 1979-80 use J8125193 †  
8 Cyl : CJ, 1981 use J8133281

**NOTE:**

1. WITH AIR CONDITIONING. WITHOUT A.C. USE J8132695.

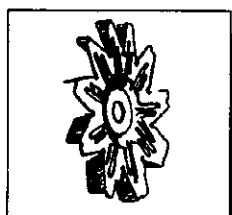

**3.017**

**FAN, Alternator**  
With American Air

8 Cyl : CJ, 1979 use J8131729  
8 Cyl : CJ, 1980-81 use J8997324

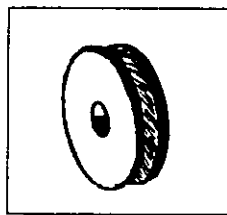

**3.017**

**PULLEY, Alternator**  
With American Air

8 Cyl : CJ, 1979-81 use J8131728

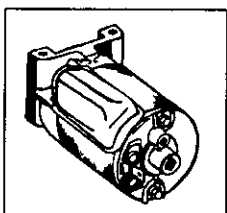

**3.020**

**STARTING MOTOR**

4 Cyl : CJ, 1980-81 use J3236659  
4 Cyl : CJ, 1982-83 use J8134193 †  
4 Cyl : CJ, 1984-86 use J3242283  
4 Cyl : Wr, 1987-89 use 53002125

6 Cyl : CJ, 1979-86 use J5752791  
6 Cyl : Wr, 1987 use J5752791  
6 Cyl : Wr, 1988-89 use 33002709

8 Cyl : CJ, 1979-81 use J5752791

**NOTE:** 1. WITH AMC ENGINE USE J3242283.

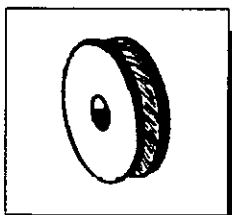

**3.017**

**PULLEY, Alternator**  
W.O American Air ; Single Groove

4 Cyl : CJ, 1981-82 use J8125192  
4 Cyl : CJ, 1983-86 use J8132698 †  
4 Cyl : Wr, 1987-89 use J8132698

6 Cyl : CJ, 1979-82 use J8125192  
6 Cyl : CJ, 1983-86 use J8132698 †  
6 Cyl : Wr, 1987-89 use J8132698

8 Cyl : CJ, 1979-81 use J8125192

**NOTE:** 1. W/ SERPENTINE DRIVE USE J8134194.



**3.024**

**RELAY, Starting Motor (Solenoid)**

4 Cyl : CJ, 1980 use J8130938  
4 Cyl : CJ, 1981-83 use J5758600 †  
4 Cyl : CJ, 1984-86 use J3235898  
4 Cyl : Wr, 1987-89 use 83502614

6 Cyl : CJ, 1979-86 use J3235898 †  
6 Cyl : Wr, 1987 use J3235898 †  
6 Cyl : Wr, 1988-89 use 83503655

8 Cyl : CJ, 1979-81 use J3235898

**NOTE:**

1. WITH AMC ENGINE USE J3235898.  
2. WITH AUTOMATIC TRANS USE J5752125.  
3. WITH AUTOMATIC TRANS USE J3235897.

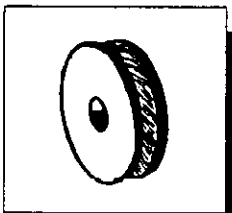

**3.017**

**PULLEY, Alternator**  
W/O American Air ; Double Groove

4 Cyl : CJ, 1981-86 use J8128522 †  
4 Cyl : Wr, 1987-89 use J8134194

6 Cyl : CJ, 1979-80 use J8128522 †  
6 Cyl : Wr, 1987-89 use J8134194

8 Cyl : CJ, 1979-81 use J8128522 †

**NOTE:** 1. W/ SERPENTINE DRIVE USE J8134194

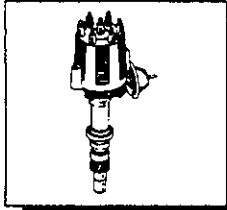

**3.030**

**DISTRIBUTOR, W/O Cap & Rotor**  
With Manual Transmission

4 Cyl : CJ, 1983-84 use J3242700  
4 Cyl : Wr, 1987-89 use 53002107<sup>3</sup>

6 Cyl : CJ, 1979 use J3232434<sup>1</sup>  
6 Cyl : CJ, 1980 use J3235141<sup>2</sup>  
6 Cyl : CJ, 1981 use J3238428  
6 Cyl : CJ, 1982 use J3241334  
6 Cyl : CJ, 1983-84 use J3242409  
6 Cyl : Wr, 1987-89 use 33002353<sup>4</sup>

8 Cyl : CJ, 1979 use J3234693  
8 Cyl : CJ, 1980-81 use J3237198

**NOTE:**

1. W/O DUAL THROAT CARBURETOR. W/ D.T. USE J3231915.
2. W/O HIGH ALTITUDE COMPENSATION. W/ H.A.C. USE J3237200.
3. OR 33004461 DEPENDING ON LABEL. IF CARBURETED ENGINE USE J3243066 OR 33004654 DEPENDING ON LABEL.
4. OR 33004655 DEPENDING ON LABEL.

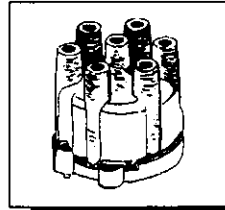

**3.032**

**CAP, Distributor**

4 Cyl : CJ, 1980-81 use J8131935  
4 Cyl : CJ, 1982-83 use J8134006<sup>1</sup>  
4 Cyl : CJ, 1984-86 use J3234451  
4 Cyl : Wr, 1987-89 use J3234451

6 Cyl : CJ, 1979-86 use J3230457  
6 Cyl : Wr, 1987-89 use J3230457

8 Cyl : CJ, 1979-81 use J3230757

**NOTE :** 1. FOR AMC ENGINE USE J3234451.

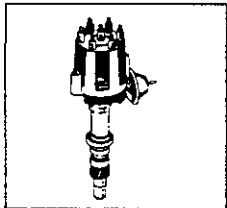

**3.030**

**DISTRIBUTOR, W/O Cap & Rotor**  
With Automatic Transmission

4 Cyl : CJ, 1980-82 use J3242700  
4 Cyl : Wr, 1987-89 use 53002107<sup>3</sup>

6 Cyl : CJ, 1979 use J3232434<sup>1</sup>  
6 Cyl : CJ, 1980-81 use J3235141<sup>2</sup>  
6 Cyl : CJ, 1982 use J3241334  
6 Cyl : CJ, 1983-84 use J3242409  
6 Cyl : Wr, 1987-89 use 33002353<sup>4</sup>

8 Cyl : CJ, 1979 use J3233959  
8 Cyl : CJ, 1980 use J3237199  
8 Cyl : CJ, 1981 use J3237198

**NOTE:** FOOTNOTES FOLLOW THOSE ABOVE.

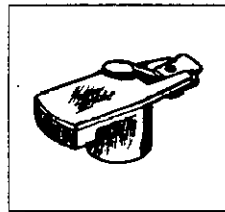

**3.035**

**ROTOR, Distributor**

4 Cyl : CJ, 1980-83 use J8131938<sup>1</sup>  
4 Cyl : CJ, 1984-86 use J3234452  
4 Cyl : Wr, 1987-89 use J3234452

6 Cyl : CJ, 1979-86 use J3230821  
6 Cyl : Wr, 1987-89 use J3230821

8 Cyl : CJ, 1979-81 use J3230765

**NOTE:** 1. FOR AMC ENGINE USE J3234452.

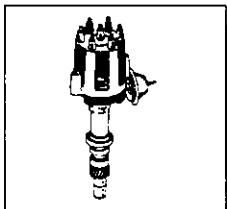

**3.030**

**DISTRIBUTOR, With Cap & Rotor**

4 Cyl : CJ, 1980 use J8130962<sup>1</sup>  
4 Cyl : CJ, 1981 use J8133516  
4 Cyl : CJ, 1982-83 use J8134001

**NOTE:**

1. WITH AUTOMATIC TRANS USE J8130961.

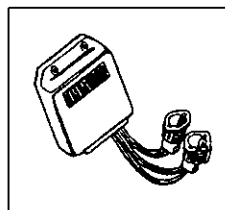

**3.044**

**MODULE, Solid State Ignition**

4 Cyl : CJ, 1980-86 use J3230451  
4 Cyl : Wr, 1987 use J3230451  
4 Cyl : Wr, 1988-89 use 53005079

6 Cyl : CJ, 1979-86 use J3230451  
6 Cyl : Wr, 1987 use J3230451  
6 Cyl : Wr, 1987-89 use 53005079

8 Cyl : CJ, 1979-81 use J3230451

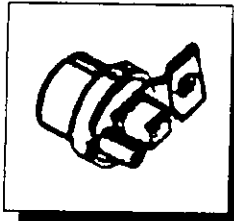

**3.051**

**SOLENOID**, Distributor Vacuum Control

- 4 Cyl : CJ, 1980-86 use J3218737
- 6 Cyl : CJ, 1979-86 use J3218737
- 8 Cyl : CJ, 1979-81 use J3218737

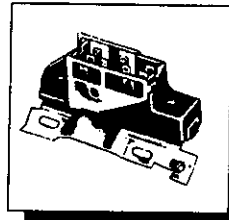

**3.130**

**SWITCH**, Ignition (W/O Cylinder)

- 4 Cyl : CJ, 1980-86 use J8128889
- 4 Cyl : Wr, 1987-89 use J8128889
- 6 Cyl : CJ, 1979-86 use J8128889
- 6 Cyl : Wr, 1987-89 use J8128889
- 8 Cyl : CJ, 1979-81 use J8128889

**NOTE:**

1. WITHOUT ADJUSTING STEERING WHEEL. WITH A.S.W. USE J8128890.

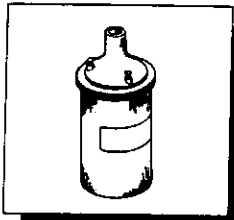

**3.056**

**COIL**, Ignition

- 4 Cyl : CJ, 1980-81 use J8131936
- 4 Cyl : CJ, 1982-83 use J8134003
- 4 Cyl : CJ, 1984-86 use J3230427
- 4 Cyl : Wr, 1987-89 use T1031135
- 6 Cyl : CJ, 1979-86 use J3230427
- 6 Cyl : Wr, 1987 use J3230427
- 6 Cyl : Wr, 1988-89 use 33004522
- 8 Cyl : CJ, 1979-81 use J3230427

NOTE: 1. FOR AMC ENGINE USE J3230427.

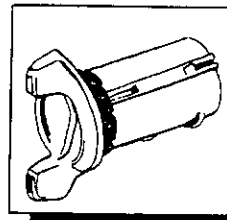

**3.135**

**CYLINDER**, Ignition Switch with Tumblers, Springs, Retainers & Keys

- 4 Cyl : CJ, 1980-84 use 8120081K
- 4 Cyl : CJ, 1985-86 use 83501971
- 4 Cyl : Wr, 1987-89 use 83501971
- 6 Cyl : CJ, 1979-84 use 8120081K
- 6 Cyl : CJ, 1985-86 use 83501971
- 6 Cyl : Wr, 1987-89 use 83501971
- 8 Cyl : CJ, 1979-81 use 8120081K

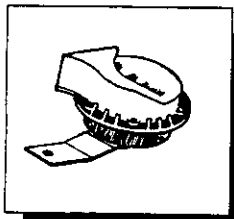

**3.105**

**HORN**, Single

- 4 Cyl : CJ, 1980-86 use J5464492
- 4 Cyl : Wr, 1987-89 use J5758484
- 6 Cyl : CJ, 1979-86 use J5464492
- 6 Cyl : Wr, 1987-89 use J5758484
- 8 Cyl : CJ, 1979-81 use J5464492

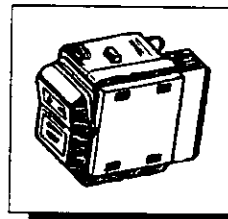

**3.145**

**SWITCH**, Lighting (Headlamp & Instruments)

- 4 Cyl : CJ, 1980-86 use J5751098
- 4 Cyl : Wr, 1987-89 use 56001862
- 6 Cyl : CJ, 1979-86 use J5751098
- 6 Cyl : Wr, 1987-89 use 56001862
- 8 Cyl : CJ, 1979-81 use J5751098

NOTE: 1. FOR 1979-80, IF NOT STAMPED USE J5450558.

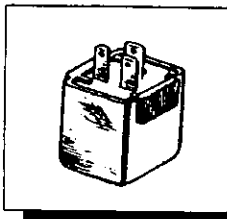

**3.125**

**RELAY**, Horn

- 4 Cyl : CJ, 1980-82 use J5456647
- 4 Cyl : CJ, 1983-86 use J5764039
- 4 Cyl : Wr, 1987-89 use J5764039
- 6 Cyl : CJ, 1979-82 use J5456647
- 6 Cyl : CJ, 1983-86 use J5764039
- 6 Cyl : Wr, 1987-89 use J5764039
- 8 Cyl : CJ, 1979-81 use J5456647

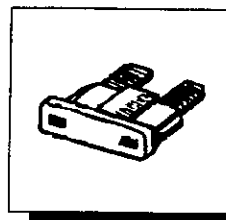

**3.155**

**FUSE**

- 3 AMP use J3231211
- 5 AMP use J3231213
- 10 AMP use J3231215
- 15 AMP use J3231216
- 20 AMP use J3231217
- 25 AMP use J3231218

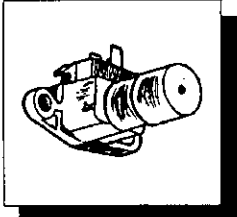

**3.158**

**SWITCH, Headlight Dimmer**

4 Cyl : CJ, 1980-86 use J5461816  
 4 Cyl : Wr, 1987-89 use J3239703  
 6 Cyl : CJ, 1979-86 use J5461816  
 6 Cyl : Wr, 1987-89 use J3239703  
 8 Cyl : CJ, 1979-81 use J5461816

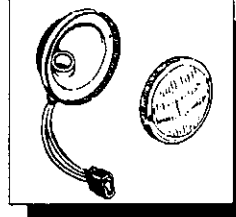

**3.292**

**LAMP, Parking & Front Directional Signal**

4 Cyl : CJ, 1980-86 use J5752771  
 4 Cyl : Wr, 1987-89 use 56001378  
 6 Cyl : CJ, 1979-86 use J5752771  
 6 Cyl : Wr, 1987-89 use 56001378  
 8 Cyl : CJ, 1979-81 use J5752771

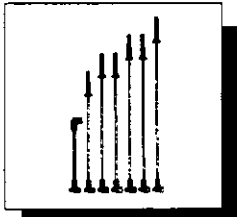

**3.228**

**WIRE SET, Ignition**

4 Cyl : CJ, 1980-81 use J8132524  
 4 Cyl : CJ, 1982-83 use J8134004  
 4 Cyl : CJ, 1984-86 use 83500276  
 4 Cyl : Wr, 1987-89 use 83502400  
 6 Cyl : CJ, 1979-86 use J8129046  
 6 Cyl : Wr, 1987-89 use J8134371  
 8 Cyl : CJ, 1979-81 use J8129048

**NOTE:** 1. 1982-83 GM ENGINES, WIRE SETS ARE LESS COIL WIRES. ADD J8134005 COIL WIRE TO COMPLETE. FOR 1983, WITH AMC ENGINE USE 83500276.  
 2. LESS COIL WIRE, ADD 53002177.

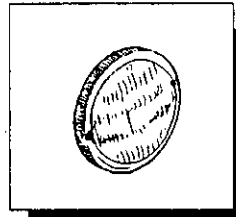

**3.292**

**LENS, Parking & Front Directional Signal Lamp**

4 Cyl : CJ, 1980-86 use J8127449  
 6 Cyl : CJ, 1979-86 use J8127449  
 8 Cyl : CJ, 1979-81 use J8127449

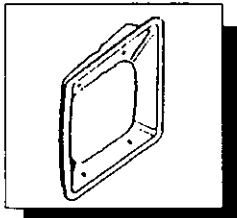

**3.252**

**DOOR, Headlamp**

4 Cyl : CJ, 1980-86 use J5460087  
 4 Cyl : Wr, 1987-89 use 56030069  
 6 Cyl : CJ, 1979-86 use J5460087  
 6 Cyl : Wr, 1987-89 use 56030069  
 8 Cyl : CJ, 1979-81 use J5460087

**NOTE:**  
 1. FOR LEFT SIDE, IN CHROME. FOR NEUTRAL COLOR TO BE PAINTED USE 56001909. FOR RIGHT SIDE, IN CHROME USE 56030070. FOR NEUTRAL COLOR USE 56001908.

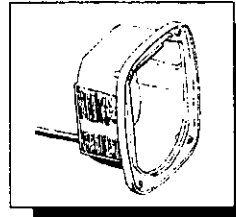

**3.300**

**LAMP ASSY, Tail, Stop & Rear Directional - Left**

4 Cyl : CJ, 1980 use J5457197  
 4 Cyl : CJ, 1981-86 use J5758255  
 4 Cyl : Wr, 1987-89 use 56002135  
 6 Cyl : CJ, 1979-80 use J5457197  
 6 Cyl : CJ, 1981-86 use J5758255  
 6 Cyl : Wr, 1987-89 use 56002135  
 8 Cyl : CJ, 1979-80 use J5457197  
 8 Cyl : CJ, 1981 use J5758255

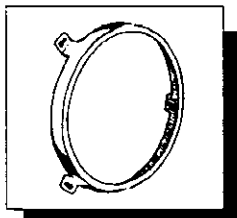

**3.275**

**RING, Headlamp Retaining**

4 Cyl : CJ, 1980-86 use J8128749  
 4 Cyl : Wr, 1987-89 use 56001260  
 6 Cyl : CJ, 1979-86 use J8128749  
 6 Cyl : Wr, 1987-89 use 56001260  
 8 Cyl : CJ, 1979-81 use J8128749

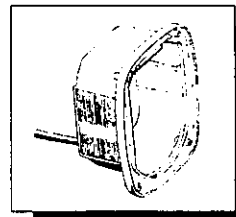

**3.300**

**LAMP ASSY, Tail, Stop & Rear Directional - Right**

4 Cyl : CJ, 1980 use J5457198  
 4 Cyl : CJ, 1981-86 use J5758254  
 4 Cyl : Wr, 1987-89 use 56002134  
 6 Cyl : CJ, 1979-80 use J5457198  
 6 Cyl : CJ, 1981-86 use J5758254  
 6 Cyl : Wr, 1987-89 use 56002134  
 8 Cyl : CJ, 1979-80 use J5457198  
 8 Cyl : CJ, 1981 use J5758254

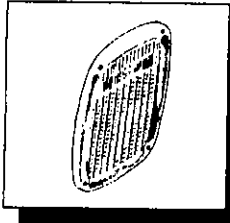

**3.306**

**LENS, Tail and Stop Lamp**

4 Cyl : CJ, 1980-86 use J5457724  
 4 Cyl : Wr, 1987-89 use J5457724  
 6 Cyl : CJ, 1979-86 use J5457724  
 6 Cyl : Wr, 1987-89 use J5457724  
 8 Cyl : CJ, 1979-81 use J5457724

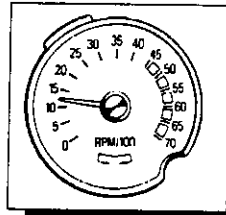

**3.550**

**SPEEDOMETER, Kilos**

4 Cyl : CJ, 1980-81 use J8131784  
 4 Cyl : CJ, 1982-86 use J8134186  
 4 Cyl : Wr, 1987 use 56001595  
 4 Cyl : Wr, 1988-89 use 56001916  
 6 Cyl : CJ, 1979 use J8128570  
 6 Cyl : CJ, 1980-81 use J8131784  
 6 Cyl : CJ, 1982-86 use J8134186  
 6 Cyl : Wr, 1987 use 56001595  
 6 Cyl : Wr, 1988-89 use 56001916  
 8 Cyl : CJ, 1979 use J8128570  
 8 Cyl : CJ, 1980-81 use J8131784

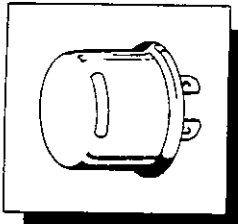

**3.330**

**FLASHER, Directional Signal**

4 Cyl : CJ, 1980-86 use J3212068  
 4 Cyl : Wr, 1987-89 use J3212068  
 6 Cyl : CJ, 1979-86 use J3212068  
 6 Cyl : Wr, 1987-89 use J3212068  
 8 Cyl : CJ, 1979-81 use J3212068

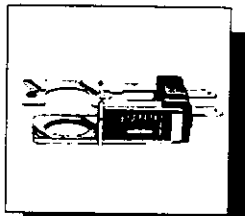

**3.333**

**SWITCH, Stop Lamp**

4 Cyl : CJ, 1980-86 use J5352620  
 4 Cyl : Wr, 1987-89 use J3225787  
 6 Cyl : CJ, 1979-86 use J5352620  
 6 Cyl : Wr, 1987-89 use J3225787  
 8 Cyl : CJ, 1979-81 use J5352620

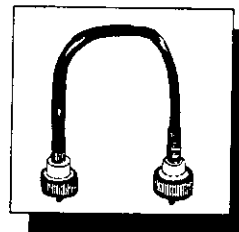

**3.570**

**CABLE, Speedometer (with core)**

4 Cyl : CJ, 1980-83 use J5752395  
 4 Cyl : CJ, 1984-86 use J5751959  
 4 Cyl : Wr, 1987 use 53002506<sup>2</sup>  
 4 Cyl : Wr, 1988-89 use 53005084<sup>3</sup>  
 6 Cyl : CJ, 1979 use J5351777<sup>4</sup>  
 6 Cyl : CJ, 1980-86 use J5751959  
 6 Cyl : Wr, 1987 use 53002506<sup>2</sup>  
 6 Cyl : Wr, 1988-89 use 53005084<sup>3</sup>  
 8 Cyl : CJ, 1979 use J5351777<sup>4</sup>  
 8 Cyl : CJ, 1980-81 use J5751959

NOTE: 1. WITHOUT AUTOMATIC SPEED CONTROL USE J3215938.

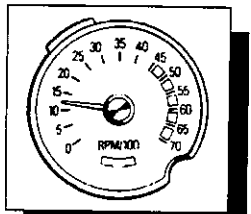

**3.550**

**SPEEDOMETER, Miles**

4 Cyl : CJ, 1980 use J8131750<sup>2</sup>  
 4 Cyl : CJ, 1981 use J8133350  
 4 Cyl : CJ, 1982-86 use J8134184  
 4 Cyl : Wr, 1987 use 56001594  
 4 Cyl : Wr, 1988-89 use 56002918  
 6 Cyl : CJ, 1979 use J8127642<sup>1</sup>  
 6 Cyl : CJ, 1980 use J8131750<sup>2</sup>  
 6 Cyl : CJ, 1981 use J8133350  
 6 Cyl : CJ, 1982-86 use J8134184  
 6 Cyl : Wr, 1987 use 56001594  
 6 Cyl : Wr, 1988-89 use 56002918  
 8 Cyl : CJ, 1979 use J8127642<sup>1</sup>  
 8 Cyl : CJ, 1980 use J8131750<sup>2</sup>  
 8 Cyl : CJ, 1981 use J8133350

NOTE: 1. FOR LEADED FUEL USE J8127641.  
 2. FOR 90 M.P.H. USE J8131753.

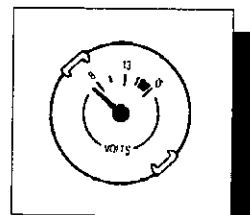

**3.600**

**VOLTMETER**

4 Cyl : CJ, 1980-82 use J5750278<sup>1</sup>  
 4 Cyl : Wr, 1987-89 use 56001390  
 6 Cyl : CJ, 1979-80 use J5750278<sup>1</sup>  
 6 Cyl : Wr, 1987-89 use 56001390  
 8 Cyl : CJ, 1979-81 use J5750278<sup>1</sup>

NOTE: 1. 1979-80, FOR VOLTMETER OR OIL GAUGE HAVING A DEPTH OF 2" USE J5460641.

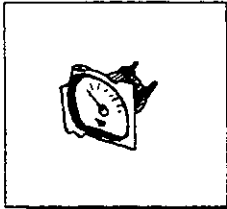

**3.605**

**GAUGE, Oil Pressure**  
(in Instrument Cluster)

4 Cyl : CJ, 1980-86 use J5750279<sup>1</sup>  
4 Cyl : Wr, 1987-89 use 56001389

6 Cyl : CJ, 1979-86 use J5750279<sup>1</sup>  
6 Cyl : Wr, 1987-89 use 56001389

8 Cyl : CJ, 1979-81 use J5750279<sup>1</sup>

NOTE: 1. 1979-80, FOR GAUGE WITH DEPTH OF 2" USE J5460640.

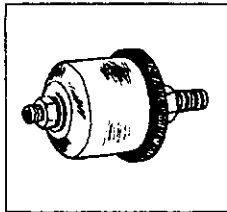

**3.605**

**SENDING UNIT, Oil Pressure**

4 Cyl : CJ, 1980-81 use J3212004<sup>1</sup>  
4 Cyl : CJ, 1982-83 use J3241716<sup>2</sup>  
4 Cyl : CJ, 1984-86 use J3212004  
4 Cyl : Wr, 1987-89 use 53000834

6 Cyl : CJ, 1979-86 use J3212004<sup>1</sup>  
6 Cyl : Wr, 1987-89 use 53000834

8 Cyl : CJ, 1979-81 use J3212004<sup>1</sup>

NOTE: 1. 1979, FOR GAUGE WITH DEPTH OF 2" USE J5460643.  
2. WITH AMC ENGINE USE J3212004.

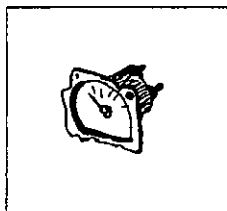

**3.610**

**GAUGE, Water Temperature**

4 Cyl : CJ, 1980-86 use J8126920  
4 Cyl : Wr, 1987-89 use 56001387

6 Cyl : CJ, 1979-86 use J8126920  
6 Cyl : Wr, 1987-89 use 56001387

8 Cyl : CJ, 1979-81 use J8126920

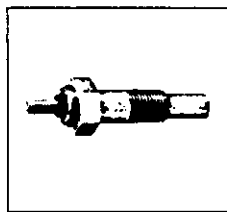

**3.610**

**SENDING UNIT, Water Temperature**

4 Cyl : CJ, 1980-83 use J5751811<sup>1</sup>  
4 Cyl : CJ, 1984-86 use J3177594  
4 Cyl : Wr, 1987 use 53004981  
4 Cyl : Wr, 1988-89 use 53005056

6 Cyl : CJ, 1979-86 use J3177594  
6 Cyl : Wr, 1987 use 53004981  
6 Cyl : Wr, 1988-89 use 53005056

8 Cyl : CJ, 1979-81 use J3177594

NOTE: 1. WITH AMC ENGINE USE J3177594.



**3.615**

**GAUGE, Fuel**

4 Cyl : CJ, 1980-86 use J8126919  
4 Cyl : Wr, 1987-89 use 56001386

6 Cyl : CJ, 1979-86 use J8126919  
6 Cyl : Wr, 1987-89 use 56001386

8 Cyl : CJ, 1979-81 use J8126919

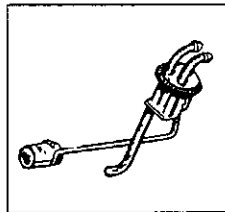

**3.615**

**SENDING UNIT, Fuel Tank**

4 Cyl : CJ, 1980-86 use J5357373<sup>1</sup>  
4 Cyl : Wr, 1987-89 use 83502990<sup>2</sup>

6 Cyl : CJ, 1979-86 use J5357373<sup>1</sup>  
6 Cyl : Wr, 1987-89 use 53003204<sup>3</sup>

8 Cyl : CJ, 1979-81 use J5357373

NOTE: 1. 1982-86, FOR 20 GALLON TANK USE J5362090.  
2. FOR 20 GALLON TANK USE 83502991.  
3. FOR 20 GALLON TANK USE 53003341.

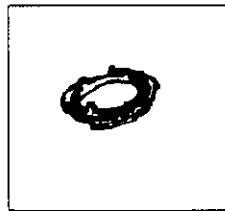

**3.615**

**LOCK, To Fuel Tank (15 Gallon)**

4 Cyl : CJ, 1980-86 use J0929669<sup>1</sup>  
4 Cyl : Wr, 1987-89 use 53000584

6 Cyl : CJ, 1979-86 use J0929669<sup>1</sup>  
6 Cyl : Wr, 1987-89 use 53000584

8 Cyl : CJ, 1979-81 use J0929669

NOTE: 1. 1982-86, FOR 20 GALLON TANK USE J5370014.

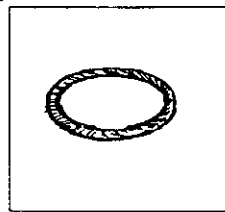

**3.615**

**GASKET, To Fuel Tank**

4 Cyl : CJ, 1980-83 use J0941521  
4 Cyl : Wr, 1987-89 use 53000575<sup>1</sup>

6 Cyl : CJ, 1979-86 use J0941521  
6 Cyl : Wr, 1987-89 use 53000575<sup>1</sup>

8 Cyl : CJ, 1979-81 use J0941521

NOTE:  
1. THIS IS AN O-RING FOR 14.5 GALLON TANK.  
FOR 20 GALLON TANK USE GASKET 53004225.

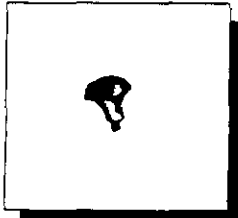

**3.690**

**KNOB, Hazard Warning**

4 Cyl : CJ, 1980 use J3229794  
 4 Cyl : CJ, 1981-86 use J3238343  
 4 Cyl : Wr, 1987-89 use 52003425  
  
 6 Cyl : CJ, 1979-80 use J3229794  
 6 Cyl : CJ, 1981-86 use J3238343  
 6 Cyl : Wr, 1987-89 use 52003425  
  
 8 Cyl : CJ, 1979-80 use J3229794  
 8 Cyl : CJ, 1981 use J3238343

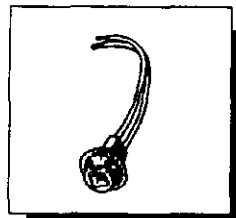

**3.720**

**CABLE, Front Fender Side Lamp**

4 Cyl : CJ, 1980-86 use J4489395  
 6 Cyl : CJ, 1979-86 use J4489395  
 8 Cyl : CJ, 1979-81 use J4489395

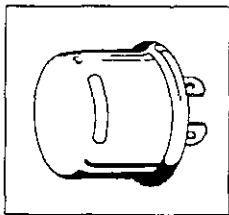

**3.690**

**FLASHER, Hazard Warning**

4 Cyl : CJ, 1980-86 use J5452266  
 4 Cyl : Wr, 1987-89 use J5452266  
  
 6 Cyl : CJ, 1979-86 use J5452266  
 6 Cyl : Wr, 1987-89 use J5452266  
  
 8 Cyl : CJ, 1979-81 use J5452266

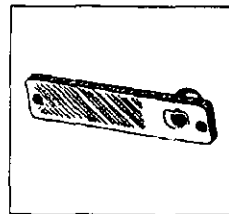

**3.740**

**LAMP, Rear Fender Side Marker  
(Mounted on Body)**

4 Cyl : CJ, 1980-86 use J0994021  
 6 Cyl : CJ, 1979-86 use J0994021  
 8 Cyl : CJ, 1979-81 use J0994021

**NOTE:**  
 1. MOUNTED ON TIRE BRACKET USE J0994035.

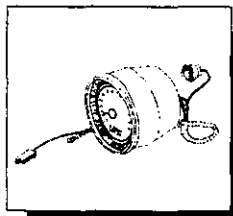

**3.700**

**TACHOMETER**

4 Cyl : CJ, 1980 use J5751839  
 4 Cyl : CJ, 1981-86 use J5758492  
 4 Cyl : Wr, 1987 use 56001380  
 4 Cyl : Wr, 1988-89 use 56002914  
  
 6 Cyl : CJ, 1979-86 use J5459418  
 6 Cyl : Wr, 1987 use 56001565  
 6 Cyl : Wr, 1988-89 use 56002915  
  
 8 Cyl : CJ, 1979-81 use J5459419

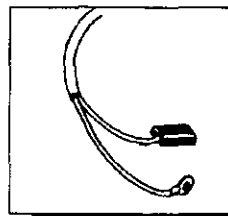

**3.742**

**CABLE, Rear Side Marker Lamp**

4 Cyl : CJ, 1980 use J5455853  
 4 Cyl : CJ, 1981-86 use J5758763  
  
 6 Cyl : CJ, 1979-80 use J5455853  
 6 Cyl : CJ, 1981-86 use J5758763  
  
 8 Cyl : CJ, 1979-80 use J5455853  
 8 Cyl : CJ, 1981 use J5758763

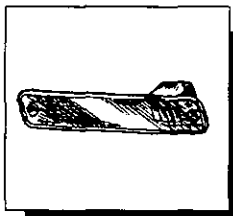

**3.720**

**LAMP, Front Fender Side Marker**

4 Cyl : CJ, 1980-86 use J0994020  
 4 Cyl : Wr, 1987-89 use 56001424  
  
 6 Cyl : CJ, 1979-86 use J0994020  
 6 Cyl : Wr, 1987-89 use 56001424  
  
 8 Cyl : CJ, 1979-81 use J0994020



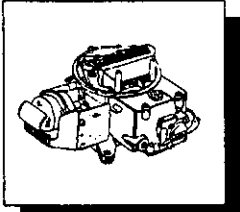

4.001

**CARBURETOR, Dual Throat**  
With Manual Transmission

4 Cyl : CJ, 1980 use J3237102  
4 Cyl : CJ, 1981 use J3238911  
4 Cyl : CJ, 1982-83 use J3241118  
4 Cyl : Wr, 1987-89 use 53002641

6 Cyl : CJ, 1979 use J3233777<sup>1</sup>  
6 Cyl : CJ, 1980 use J3235769<sup>2</sup>  
6 Cyl : CJ, 1981 use J3238403  
6 Cyl : CJ, 1982 use J3241125  
6 Cyl : CJ, 1983 use 33000469  
6 Cyl : CJ, 1984-86 use 33001708  
6 Cyl : Wr, 1987-89 use 33001708

8 Cyl : CJ, 1979 use J3233978  
8 Cyl : CJ, 1980 use J3235794  
8 Cyl : CJ, 1981 use J3238410

NOTE: 1. WITH 258 FOR HILLY TERRAIN USE J3235438.  
2. FOR HILLY TERRAIN USE J3236626.

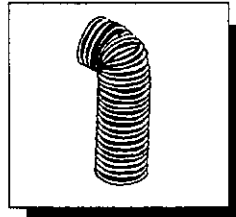

4.015

**TUBE, Air Cleaner Duct (Hot Air)**

4 Cyl : CJ, 1980-82 use J3236608  
4 Cyl : CJ, 1983 use 33001525  
4 Cyl : CJ, 1984-86 use 33001949  
4 Cyl : Wr, 1987-89 use 53002737<sup>1</sup>

6 Cyl : CJ, 1979-86 use J3229841  
6 Cyl : Wr, 1987-89 use 33003391

8 Cyl : CJ, 1979-81 use J3229841

NOTE: 1. FOR FUEL INJECTION USE 53004590.

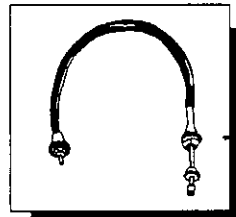

4.057

**CABLE, Accelerator**

4 Cyl : CJ, 1980-83 use J5361067<sup>1</sup>  
4 Cyl : CJ, 1984-86 use J5364684  
4 Cyl : Wr, 1987-89 use 52040430<sup>2</sup>

6 Cyl : CJ, 1979-80 use J5358677  
6 Cyl : CJ, 1981-86 use J5362801  
6 Cyl : Wr, 1987-89 use 52040274

8 Cyl : CJ, 1979-81 use J5357931

NOTE:

1. 1983, WITH AMC ENGINE USE J5364684.  
2. FOR FUEL INJECTION USE 52040199.

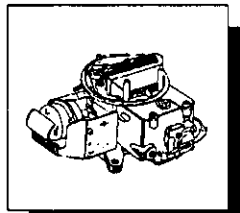

4.001

**CARBURETOR, Dual Throat**  
With Automatic Transmission

4 Cyl : CJ, 1981 use J3238910

6 Cyl : CJ, 1979 use J3233776  
6 Cyl : CJ, 1980 use J3235768  
6 Cyl : CJ, 1981 use J3238402  
6 Cyl : CJ, 1982 use J3241125  
6 Cyl : CJ, 1983 use 33000482  
6 Cyl : CJ, 1984-86 use 33001707  
6 Cyl : Wr, 1987-89 use 33001707

8 Cyl : CJ, 1979-81 use J3233980  
8 Cyl : CJ, 1980 use J3235793  
8 Cyl : CJ, 1981 use J3238409

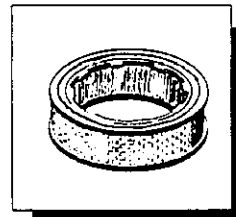

4.088

**ELEMENT, Carburetor Air Cleaner**

4 Cyl : CJ, 1980-86 use J8991386  
4 Cyl : Wr, 1987-89 use J8991386<sup>1</sup>

6 Cyl : CJ, 1979-86 use J8991386  
6 Cyl : Wr, 1987-89 use J8991386<sup>2</sup>

8 Cyl : CJ, 1979-81 use J8992661

NOTE:

1. FOR FUEL-INJECTED ENGINE USE 53002184.  
2. FOR "SEVERE USE" USE 53003676.

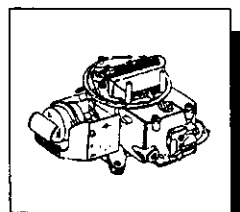

4.001

**CARBURETOR,**  
Without Dual Throat

4 Cyl : CJ, 1983 use 53000651  
4 Cyl : CJ, 1984 use 33002115  
4 Cyl : CJ, 1985-86 use 53002637

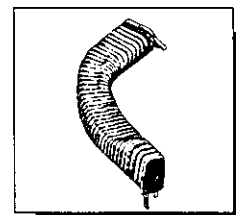

4.092

**DUCT, Cold Air Induction**

4 Cyl : CJ, 1980-86 use J3236526<sup>1</sup>  
4 Cyl : Wr, 1987-89 use 53002185

6 Cyl : CJ, 1979-86 use J3229610<sup>2</sup>

8 Cyl : CJ, 1979-81 use J5357889

NOTE: 1. FOR LOWER USE J5358444. FOR 1983, WITH AMC ENGINE USE J5357889.  
2. WITH POWER BRAKES USE J5359272.

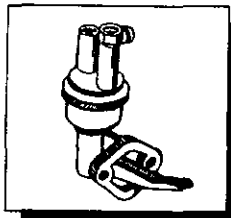

**4.110**

**PUMP, Fuel**

4 Cyl : CJ, 1980-83 use J8132364 <sup>2</sup>  
 4 Cyl : CJ, 1984-86 use J3228191  
 4 Cyl : Wr, 1987-89 use 33002652

6 Cyl : CJ, 1979-86 use J3228191  
 6 Cyl : Wr, 1987-89 use J3228191 <sup>1</sup>

8 Cyl : CJ, 1979-81 use J3227884

NOTE: 1. INLET FITTING IS TOWARD REAR OF ENGINE. IF FITTING IS TOWARD FRONT OF ENGINE USE J3240172.

2. WITH AMC ENGINE USE J3228191.

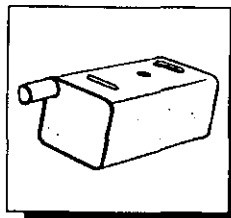

**4.130**

**FUEL TANK, Assembly - 15 Gallon**

4 Cyl : CJ, 1980-86 use J8128585 <sup>1</sup>  
 4 Cyl : Wr, 1987-89 use 83502961 <sup>2</sup>

6 Cyl : CJ, 1979-86 use J8128585 <sup>1</sup>  
 6 Cyl : Wr, 1987-89 use 83502960 <sup>3</sup>

8 Cyl : CJ, 1979-81 use J8128585

NOTE: 1. 1982-86, FOR 20 GALLON TANK USE J5362498.

2. FOR 20 GALLON TANK USE 52002633.

3. FOR 20 GALLON TANK USE 52002622.

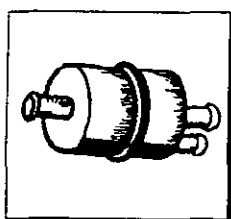

**4.110**

**FILTER, Gasoline (In-Line)**

3 -7/8" Long

4 Cyl : CJ, 1980-86 use J3229443

6 Cyl : CJ, 1979-86 use J3229443

8 Cyl : CJ, 1979-81 use J3229443

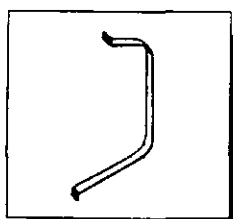

**4.131**

**STRAP, Fuel Tank (Center)**

4 Cyl : CJ, 1980-86 use J5356651  
 4 Cyl : Wr, 1987-89 use 52003437 <sup>1</sup>

6 Cyl : CJ, 1979-86 use J5356651  
 6 Cyl : Wr, 1987-89 use 52003437 <sup>1</sup>

8 Cyl : CJ, 1979-81 use J5356651

NOTE: 1. FOR 20 GALLON TANK USE J5356651

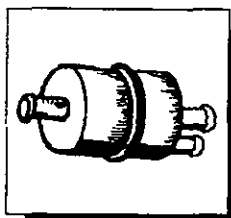

**4.110**

**FILTER KIT, Fuel Pump In-Line (With Hoses and Clamps)**

4 Cyl : CJ, 1980-86 use J8129383  
 4 Cyl : Wr, 1987-89 use J8129383

6 Cyl : CJ, 1979-86 use J8129383  
 6 Cyl : Wr, 1987-89 use J8129383

8 Cyl : CJ, 1979-81 use J8129383

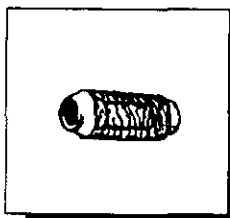

**4.134**

**FILTER, Fuel Tank**

4 Cyl : CJ, 1980-86 use J3230376  
 4 Cyl : Wr, 1987-89 use 33000184

6 Cyl : CJ, 1979-86 use J3230376  
 6 Cyl : Wr, 1987-89 use 53001248

8 Cyl : CJ, 1979-81 use J3230376

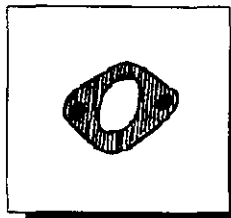

**4.116**

**GASKET, Fuel Pump**

4 Cyl : CJ, 1980 use J3174685  
 4 Cyl : CJ, 1981-83 use J8132366 <sup>1</sup>  
 4 Cyl : CJ, 1984-86 use J3174685  
 4 Cyl : Wr, 1987-89 use J3174685

6 Cyl : CJ, 1979-86 use J3174685  
 6 Cyl : Wr, 1987-89 use J3174685

8 Cyl : CJ, 1979-81 use J3174685

NOTE:

1. WITH AMC ENGINE USE J3174685.

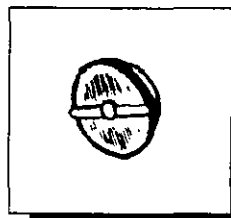

**4.138**

**CAP, Non-Locking Fuel Tank Filler**

4 Cyl : CJ, 1980-86 use J5358207  
 4 Cyl : Wr, 1987-89 use 52003766

6 Cyl : CJ, 1979-86 use J5358207  
 6 Cyl : Wr, 1987-89 use 52003766

8 Cyl : CJ, 1979-81 use J5358207

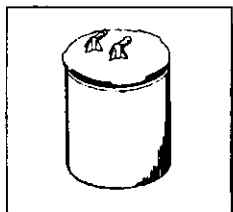

4.144

**FILTER, Fuel Vapor Storage Canister**  
(Element Only)

4 Cyl : CJ, 1980-86 use J3227279  
4 Cyl : Wr, 1987-89 use J3227279

6 Cyl : CJ, 1979-86 use J3227279  
6 Cyl : Wr, 1987-89 use J3227279

8 Cyl : CJ, 1979-81 use J3227279

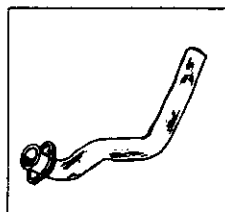

4.178

**PIPE, Exhaust - CJ-7**  
With Auto Transmission

4 Cyl : CJ, 1980 use J5361092  
4 Cyl : CJ, 1981 use J5362542  
4 Cyl : CJ, 1982 use J5363602  
4 Cyl : CJ, 1983 use J5364524<sup>1</sup>  
4 Cyl : CJ, 1984-86 use J5364648

6 Cyl : CJ, 1979 use J5358612  
6 Cyl : CJ, 1980 use J5361101  
6 Cyl : CJ, 1981 use J5362686  
6 Cyl : CJ, 1982 use J5363596  
6 Cyl : CJ, 1983-86 use J5364312

8 Cyl : CJ, 1979 use J5359062  
8 Cyl : CJ, 1980 use J5361329  
8 Cyl : CJ, 1981 use J5362635

NOTE: 1. WITH AMC ENGINE USE J5364648.

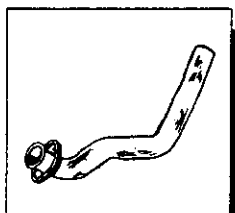

4.178

**PIPE, Exhaust - CJ-5**  
With Auto Transmission

4 Cyl : CJ, 1980 use J5361090  
4 Cyl : CJ, 1981 use J5362779  
4 Cyl : CJ, 1982 use J5363600  
4 Cyl : CJ, 1983 use J5364523<sup>1</sup>  
4 Cyl : CJ, 1984-86 use J5364648

6 Cyl : CJ, 1982 use J5363594  
6 Cyl : CJ, 1983 use J5364311

NOTE: 1. WITH AMC ENGINE USE J5364648.

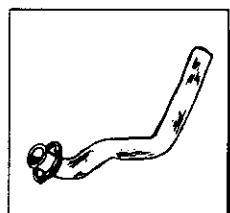

4.178

**PIPE, Exhaust - CJ-7**  
With Manual Transmission

4 Cyl : CJ, 1980 use J5361092  
4 Cyl : CJ, 1981 use J5362780  
4 Cyl : CJ, 1982 use J5363602  
4 Cyl : CJ, 1983 use J5364524<sup>3</sup>  
4 Cyl : CJ, 1984-86 use J5364648

6 Cyl : CJ, 1979 use J5358782  
6 Cyl : CJ, 1980 use J5361098<sup>1</sup>  
6 Cyl : CJ, 1981 use J5362687<sup>2</sup>  
6 Cyl : CJ, 1982 use J5363596  
6 Cyl : CJ, 1983-86 use J5364312

8 Cyl : CJ, 1979 use J5359064  
8 Cyl : CJ, 1980 use J5361121  
8 Cyl : CJ, 1981 use J5362556

NOTE:

1. USED WITH TRANSMISSION TAG NUMBER 5360956 & 5360957. WITH TRANS TAG # 5359390 & 5359391 USE J5361876.
2. WITH SR4 TRANSMISSION. WITH T176 TRANSMISSION USE J5362688.
3. WITH AMC ENGINE USE J5364648.

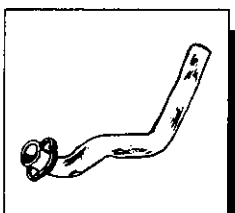

4.178

**PIPE, Exhaust - CJ-5**  
With Manual Transmission

4 Cyl : CJ, 1980 use J5361090  
4 Cyl : CJ, 1981 use J5362779  
4 Cyl : CJ, 1982 use J5363600  
4 Cyl : CJ, 1983 use J5364523<sup>1</sup>  
4 Cyl : CJ, 1984-86 use J5364648

6 Cyl : CJ, 1979 use J5358631  
6 Cyl : CJ, 1980 use J5361095  
6 Cyl : CJ, 1981 use J5362685  
6 Cyl : CJ, 1982 use J5363594  
6 Cyl : CJ, 1983 use J5364311

8 Cyl : CJ, 1979 use J5359063  
8 Cyl : CJ, 1980 use J5361118  
8 Cyl : CJ, 1981 use J5362555

NOTE: 1. WITH AMC ENGINE USE J5364648.

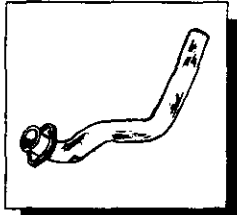

4.178

**PIPE, Exhaust - CJ-8 & Wrangler**

4 Cyl : CJ, 1981 use J5363085 <sup>1</sup>  
 4 Cyl : CJ, 1982 use J5363604  
 4 Cyl : CJ, 1983 use J5364525 <sup>3</sup>  
 4 Cyl : CJ, 1984-86 use J5364648  
 4 Cyl : Wr, 1987-89 use 52001720

6 Cyl : CJ, 1981 use J5363054 <sup>2</sup>  
 6 Cyl : CJ, 1982 use J5363598  
 6 Cyl : CJ, 1983-86 use J5364312  
 6 Cyl : Wr, 1987-89 use 52040278

**NOTE:**

1. WITH AUTO TRANSMISSION USE J5363083.
2. WITH SR4 TRANS. WITH T176 TRANS USE J5363055. WITH AUTO TRANS USE J5363053.
3. WITH AMCE ENGINE USE J5364648.

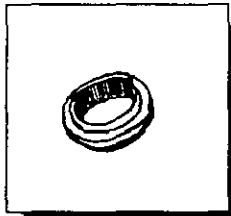

4.186

**SEAL, Exhaust Pipe To Manifold**

4 Cyl : CJ, 1982 use J3241445  
 4 Cyl : CJ, 1983 use 33001058

6 Cyl : CJ, 1979 use J3223546

8 Cyl : CJ, 1979-81 use J3223547

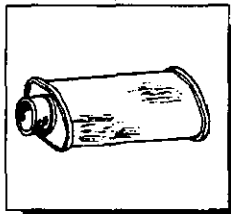

4.210

**MUFFLER, With Tailpipe**

4 Cyl : CJ, 1980 use J5359381  
 4 Cyl : CJ, 1981 use J5362725 <sup>1</sup>  
 4 Cyl : CJ, 1982-83 use J5363571 <sup>4</sup>  
 4 Cyl : CJ, 1984-86 use J5363566  
 4 Cyl : Wr, 1987-89 use 83502978 <sup>3</sup>

6 Cyl : CJ, 1979-80 use J5358841  
 6 Cyl : CJ, 1981 use J5362723 <sup>2</sup>  
 6 Cyl : CJ, 1982-86 use J5363566  
 6 Cyl : Wr, 1987-89 use 83502979 <sup>3</sup>

8 Cyl : CJ, 1979-80 use J5358842  
 8 Cyl : CJ, 1981 use J5362724

**NOTE:**

1. FOR CJ-8 USE J5363080.
2. FOR CJ-8 USE J5362150.
3. MUFFLER ONLY. TAILPIPE IS 83502980.
4. WITH AMC ENGINE USE J5363566.

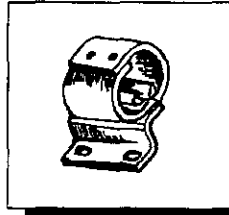

4.219

**INSULATOR, Muffler and Tailpipe Support to Side Rail (Intermediate)**

4 Cyl : CJ, 1980-81 use J5356065  
 4 Cyl : CJ, 1982-86 use J5362502  
 4 Cyl : Wr, 1987-89 use 52002400

6 Cyl : CJ, 1979-81 use J5356065  
 6 Cyl : CJ, 1982-86 use J5362502  
 6 Cyl : Wr, 1987-89 use 52002400

8 Cyl : CJ, 1979-81 use J5356065



4.234

**INSULATOR, Tailpipe Support-Rear**

4 Cyl : CJ, 1980-81 use J5353523 <sup>1</sup>  
 4 Cyl : CJ, 1982-86 use J5363891  
 4 Cyl : Wr, 1987-89 use 52040219

6 Cyl : CJ, 1979-81 use J5353523 <sup>1</sup>  
 6 Cyl : CJ, 1982-86 use J5363891  
 6 Cyl : Wr, 1987-89 use 52040219

8 Cyl : CJ, 1979-81 use J5353523

**NOTE:**

1. 1981, FOR CJ-8 USE J5362502.

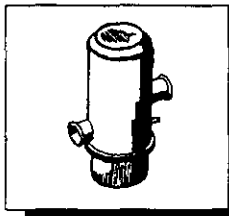

4.558

**VALVE, Exhaust Emission Backfire (Diverter)**

4 Cyl : CJ, 1980-82 use J8132346 <sup>2</sup>

6 Cyl : CJ, 1979-82 use J3223634

8 Cyl : CJ, 1979-81 use J3230822 <sup>1</sup>

**NOTE:**

1. 1980-81, WITH MANUAL TRANS. FOR AUTO TRANS USE J3223271.
2. 1982, W/ MANUAL TRANS USE J8134264.

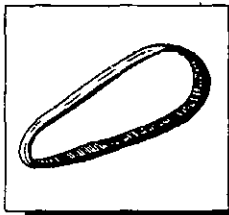

4.612

**BELT, Crankshaft to Exhaust Emission Air Pump**

6 Cyl : CJ, 1979-82 use J3226936

8 Cyl : CJ, 1979-81 use J3227692

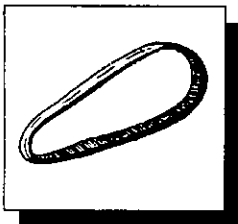

4.615

**BELT**, Power Steering Pump to Exhaust Emission Air Pump

6 Cyl : CJ, 1979-82 use J3226939

8 Cyl : CJ, 1979-81 use J3228287

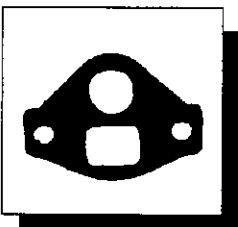

4.700

**GASKET**, Exhaust Gas Recirculating Valve and Sensor

4 Cyl : CJ, 1980 use J8132352

4 Cyl : CJ, 1981-83 use J3237589

4 Cyl : CJ, 1984-86 use J3221283

4 Cyl : Wr, 1987-89 use J3221283

6 Cyl : CJ, 1979 use J3221283

6 Cyl : Wr, 1987-89 use J3221283

8 Cyl : CJ, 1979-81 use J3221283

**NOTE:**

1. WITH AMC ENGINE USE J3221283.



**REPAIR KIT, CARBURETOR**

<u>TAG NO.</u>	<u>YEAR</u>	<u>REPAIR KIT PART NO.</u>
BBD-8185S	1979	J8127315
BBD-8186S	1979	J8127315
BBD-8188S	1979	J8127315
BBD-8229S	1979	J8130652
8DM2C	1979	J8128348
9DA2J	1979	J8128346
9DM2	1979	J8128346
9DM2H	1979	J8128346
17080685	1980	J8132749
BBD-8253S	1980	J8127315
BBD-8254S	1980	J8127315
BBD-8256S	1980	J8132617
BBD-8257S	1980	J8132617
BBD-8277S	1980	J8132617
02A2J	1980	J8128346
0DA2J	1980	J8128346
0DM2A	1980	J8128346
0DM2J	1980	J8128346
0DM2JC	1980	J8128346
BBD-8308S	1981	J8133460
BBD-8309S	1981	J8133460
BBD-8328S	1981	J8127315
1DM2J	1981	J8133820
1DA2J	1981	J8133820
17081791	1981	J8132778
17081790	1981	J8132778
17081796	1981	J8132778
17081797	1981	J8132778
BBD-8311S	1982	J8133460
BBD-8349S	1982	J8134232
BBD-8351S	1982	J8134232
17082380	1982-83	J8133978
17082389	1982	J8133488
17083385	1983	J8133488
BBD-8360S	1983	J8134232
BBD-8362S	1983	J8134232
BBD-8364S	1983	J8134232
BBD-8383S	1984-89	J8134232
BBD-8384S	1984-89	J8134232
YF-7453	1983	83500453
YF-7455	1983	83500453
YF-7700	1984	83500453
YF-7702	1984	83500453
YF-7704	1985-86	83500453
YF-7708	1987-89	83500453
BBD-8366S	1987-89	J8134232

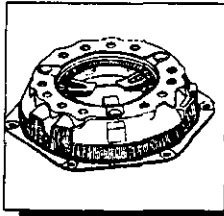

**5.001**

**COVER ASSY, Clutch**

4 Cyl : CJ, 1980-83 use J8132576  
 4 Cyl : CJ, 1984 use 53000167  
 4 Cyl : CJ, 1985-86 use 53002711  
 4 Cyl : Wr, 1987-89 use 53003006

6 Cyl : CJ, 1979-80 use J3181383  
 6 Cyl : CJ, 1981 use J3184908  
 6 Cyl : CJ, 1982-86 use J3240277  
 6 Cyl : Wr, 1987-89 use 53004678

8 Cyl : CJ, 1979-81 use J3184908

NOTE: 1. WITH AMC ENGINE USE 53000167.



**5.040**

**PLATE, Clutch Driven**

4 Cyl : CJ, 1980-83 use J8132577  
 4 Cyl : CJ, 1984 use 53000168  
 4 Cyl : CJ, 1985-86 use 53001420  
 4 Cyl : Wr, 1987-89 use 53004538

6 Cyl : CJ, 1979 use J5354689  
 6 Cyl : CJ, 1980-81 use J5360174  
 6 Cyl : CJ, 1982-86 use J3240278  
 6 Cyl : Wr, 1987-89 use 53004679

8 Cyl : CJ, 1979 use J5354689  
 8 Cyl : CJ, 1980-81 use J5360173

NOTE: 1. WITH AMC ENGINE USE 53000168.

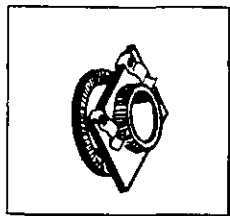

**5.109**

**SLEEVE, Clutch Throwout Lever  
 (With Bearing) <sup>2</sup>**

4 Cyl : CJ, 1980-83 use J5361614  
 4 Cyl : CJ, 1984-86 use 53000175

6 Cyl : CJ, 1979 use J3229267  
 6 Cyl : CJ, 1980-86 use J5361610

8 Cyl : CJ, 1979 use J3229267  
 8 Cyl : CJ, 1980-81 use J5361610

NOTE: 1. WITH AMC ENGINE USE 53000175.  
 2. FOR WRANGLER REFER TO GROUP 5.221

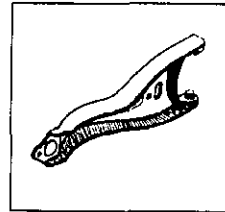

**5.123**

**LEVER, Clutch Throwout**

4 Cyl : CJ, 1980-83 use J5361620  
 4 Cyl : CJ, 1984-86 use 53000484

6 Cyl : CJ, 1979 use J3224192  
 6 Cyl : CJ, 1980-86 use J5361620

8 Cyl : CJ, 1979 use J3224192  
 8 Cyl : CJ, 1980-81 use J5361620

NOTE: 1. WITH AMC ENGINE USE 53000484.

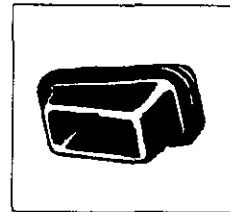

**5.125**

**BOOT, Clutch Throwout Lever**

4 Cyl : CJ, 1980-86 use J3236454

6 Cyl : CJ, 1979 use J3180370  
 6 Cyl : CJ, 1980-86 use J3236453

8 Cyl : CJ, 1979 use J3180370  
 8 Cyl : CJ, 1980-81 use J3236453

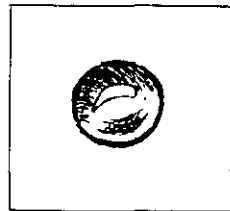

**5.130**

**BALL, Throwout Lever  
 (In Clutch Housing)**

4 Cyl : CJ, 1980-86 use G169162

6 Cyl : CJ, 1979-86 use G169162

8 Cyl : CJ, 1979-81 use G169162

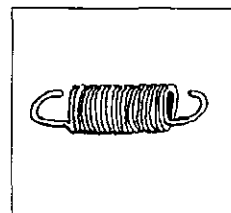

**5.132**

**SPRING, Clutch Throwout Lever  
 (In Clutch Housing)**

4 Cyl : CJ, 1980-86 use J3222799

6 Cyl : CJ, 1979-86 use J3222799

8 Cyl : CJ, 1979-81 use J3222799

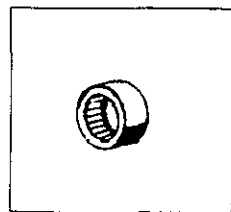

**5.135**

**BEARING, Clutch Pedal**

4 Cyl : CJ, 1980-86 use J0946177  
 4 Cyl : Wr, 1987-89 use J0946177

6 Cyl : CJ, 1979-81 use J0949169  
 6 Cyl : CJ, 1982-86 use J0946177  
 6 Cyl : Wr, 1987-89 use J0946177

8 Cyl : CJ, 1979-81 use J0949169

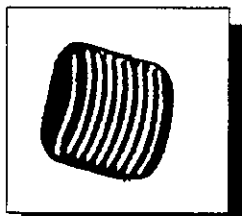

**5.144**

**COVER, Clutch Pedal Pad**

4 Cyl : CJ, 1980-81 use J0948758  
 4 Cyl : CJ, 1982-86 use J5363508  
 4 Cyl : Wr, 1987-89 use 52002750

6 Cyl : CJ, 1979-81 use J0948758  
 6 Cyl : CJ, 1982-86 use J5363508  
 6 Cyl : Wr, 1987-89 use 52002750

8 Cyl : CJ, 1979-81 use J0948758

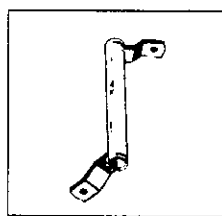

**5.168**

**BELLCRANK, Clutch Release Idler**

6 Cyl : CJ, 1979-81 use J5360104  
 6 Cyl : CJ, 1982 use J5363462  
 6 Cyl : CJ, 1983-86 use J5364621

8 Cyl : CJ, 1979-81 use J5360104

**NOTE:**

1. 1979, WITH NUT TYPE ATTACHMENT USE J5358993.

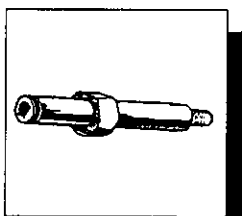

**5.148**

**SHAFT, Clutch and Brake Pedal**

4 Cyl : CJ, 1980-86 use J5359834  
 4 Cyl : Wr, 1987-89 use J5359834

6 Cyl : CJ, 1979-80 use J5351805  
 6 Cyl : CJ, 1981-86 use J5359834  
 6 Cyl : Wr, 1987-89 use J5359834

8 Cyl : CJ, 1979-80 use J5351805  
 8 Cyl : CJ, 1981 use J5359834

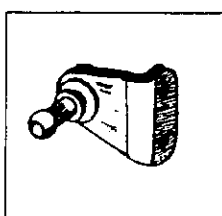

**5.168**

**SUPPORT, Clutch Release Idler Pivot**

6 Cyl : CJ, 1979 use J5355332  
 6 Cyl : CJ, 1980-86 use J5360112

8 Cyl : CJ, 1979 use J5355332  
 8 Cyl : CJ, 1980-81 use J5360112

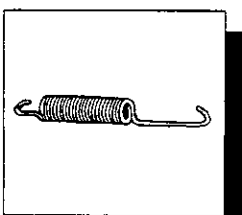

**5.155**

**SPRING, Clutch Pedal Over Center**

4 Cyl : CJ, 1980-82 use J5351050  
 4 Cyl : CJ, 1983-86 use 8133252  
 4 Cyl : Wr, 1987-89 use J5351050

6 Cyl : CJ, 1979-81 use J5357515  
 6 Cyl : CJ, 1982-86 use J5363464  
 6 Cyl : Wr, 1987-89 use J5351050

8 Cyl : CJ, 1979-81 use J5357515

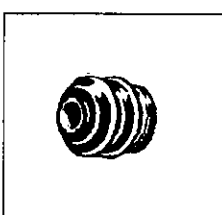

**5.168**

**BOOT, Clutch Pivot - Inner**

6 Cyl : CJ, 1979-86 use J3170937

8 Cyl : CJ, 1979-81 use J3170937

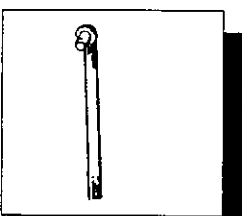

**5.160**

**ROD, Bellcrank to Clutch Pedal Shaft**

6 Cyl : CJ, 1979-81 use J5353251  
 6 Cyl : CJ, 1982-86 use J5364620

8 Cyl : CJ, 1979-81 use J5353251

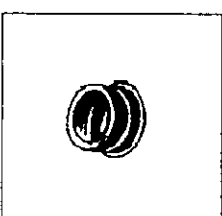

**5.168**

**BOOT, Clutch Pivot - Outer**

6 Cyl : CJ, 1979-86 use J3167049

8 Cyl : CJ, 1979-81 use J3167049

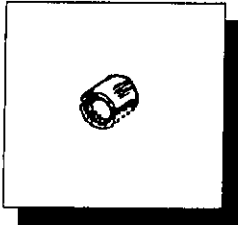

**5.168**

**BUSHING, Clutch Release Idler Pivot**  
Inner & Outer

6 Cyl : CJ, 1979-86 use J3167067  
8 Cyl : CJ, 1979-81 use J3167067

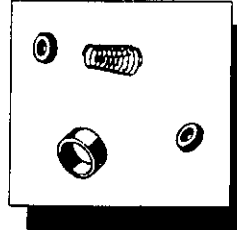

**5.211**

**REPAIR KIT, Clutch Master Cylinder**

4 Cyl : CJ, 1980-86 use J8132781  
4 Cyl : Wr, 1987-89 use 83504097  
6 Cyl : Wr, 1987-89 use 83504097

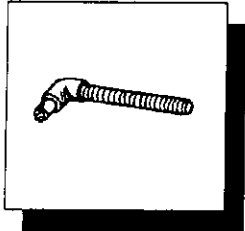

**5.187**

**ROD ASSY, Clutch Fork Release**

6 Cyl : CJ, 1979-86 use J5359943  
8 Cyl : CJ, 1979-81 use J5359943

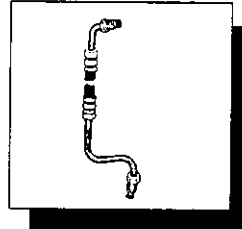

**5.213**

**TUBE, Hydraulic Clutch**

4 Cyl : CJ, 1980-83 use J5361469  
4 Cyl : CJ, 1984-86 use J5364646

NOTE: 1. WITH AMC ENGINE USE J5364646.

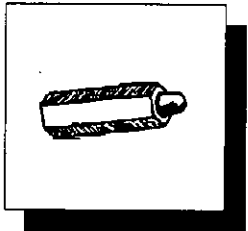

**5.187**

**ADJUSTER, Clutch Wear**

6 Cyl : CJ, 1979 use J5351209  
6 Cyl : CJ, 1980-86 use J5359735  
8 Cyl : CJ, 1979 use J5351209  
8 Cyl : CJ, 1980-81 use J5359735

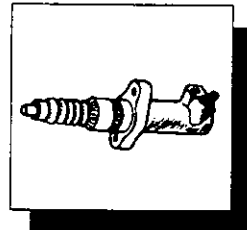

**5.221**

**SLAVE CYLINDER ASSY, Clutch**

4 Cyl : CJ, 1980-82 use J3241867  
4 Cyl : CJ, 1983-86 use 52000070  
4 Cyl : Wr, 1987-89 use 83503384  
6 Cyl : Wr, 1987-89 use 83503383

NOTE:

1. INSTEAD OF SLAVE CYLINDERS, WRANGLER USES A CLUTCH CONTROL KIT. THIS INCLUDES BEARING.

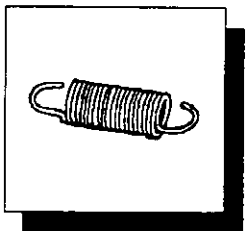

**5.190**

**SPRING, Clutch Throwout Lever**  
Return

6 Cyl : CJ, 1979-86 use J5351252  
8 Cyl : CJ, 1979-81 use J5351252

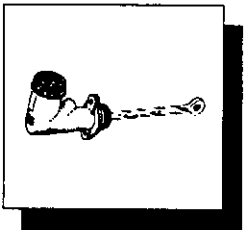

**5.207**

**CYLINDER ASSY, Clutch Master**

4 Cyl : CJ, 1980-86 use J5359822  
4 Cyl : Wr, 1987-89 use 53004466  
6 Cyl : Wr, 1987-89 use 53004466

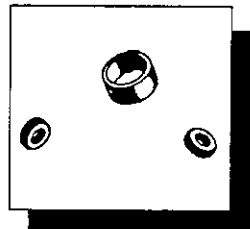

**5.227**

**REPAIR KIT, Clutch Slave Cylinder**

4 Cyl : CJ, 1980-81 use J8132782  
4 Cyl : CJ, 1982-83 use 83500678  
4 Cyl : CJ, 1984-86 use 83500670  
6 Cyl : CJ, 1979-81 use J8132782  
6 Cyl : CJ, 1982-86 use 83500678  
8 Cyl : CJ, 1979-81 use J8132782

NOTE: 1. WITH AMC ENGINE USE 83500670.



# GROUP 6: TRANSMISSION/TRANSFER CASE

CJ. WRANGLER

Year                      Application                      Type                      Part #                      Pg#

**Transmissions**

1979	CJ5/CJ7 3-SPEED	T150	J5359092	T3
1979	CJ5/CJ7 4-SPEED	T18	J5358783	T5
1980-81	CJ5/CJ7 4-SPEED	SR4	J3239675	T9
	CJ5/CJ7 4-SPEED	SR4	J5360957	T9
1981-86	CJ5/CJ7/CJ8 4-SPEED	T177	J5359389	T7
	CJ5/CJ7/CJ8 4-SPEED	T176	J5359390	T7
1982-86	CJ5/CJ7/CJ8 4-SPEED	T4 (10 SPLINE)	53001940	T11
	CJ5/CJ7/CJ8 4-SPEED	T4 (14 SPLINE)	53001941	T11
1982-86	CJ5/CJ7/CJ8 5-SPEED	T5 (10 SPLINE)	53001945	T13
	CJ5/CJ7/CJ8 5-SPEED	T5 (14 SPLINE)	53001946	T13
1987-88 (to 10/4/88)	WRANGLER 4 CYL 5-SPEED	AX5	53004224	T15
1988 (after 10/4/88)	WRANGLER 4 CYL 5-SPEED	AX5	53006176	T15
1989 (after 3/3/89)	WRANGLER 6 CYL 5-SPEED	AX15	53005360	T15
1987	WRANGLER 6 CYL 5-SPEED	BA10/5	53002035 <sup>1</sup>	T17
1988-89	WRANGLER 6 CYL 5-SPEED	BA10/5	53005451 <sup>2</sup>	T17

**Transfer Cases**

1979-86	CJ5, CJ7, CJ8	D300		T21
1987-89	WRANGLER	NP 207		T19
1989-90	WRANGLER	NP 231		T19

1. 53002035 is superceded by part number 53005330 and by part number 83505533.  
 2. 53005451 supercedes part number 53005248.

**T-150 TRANSMISSION**

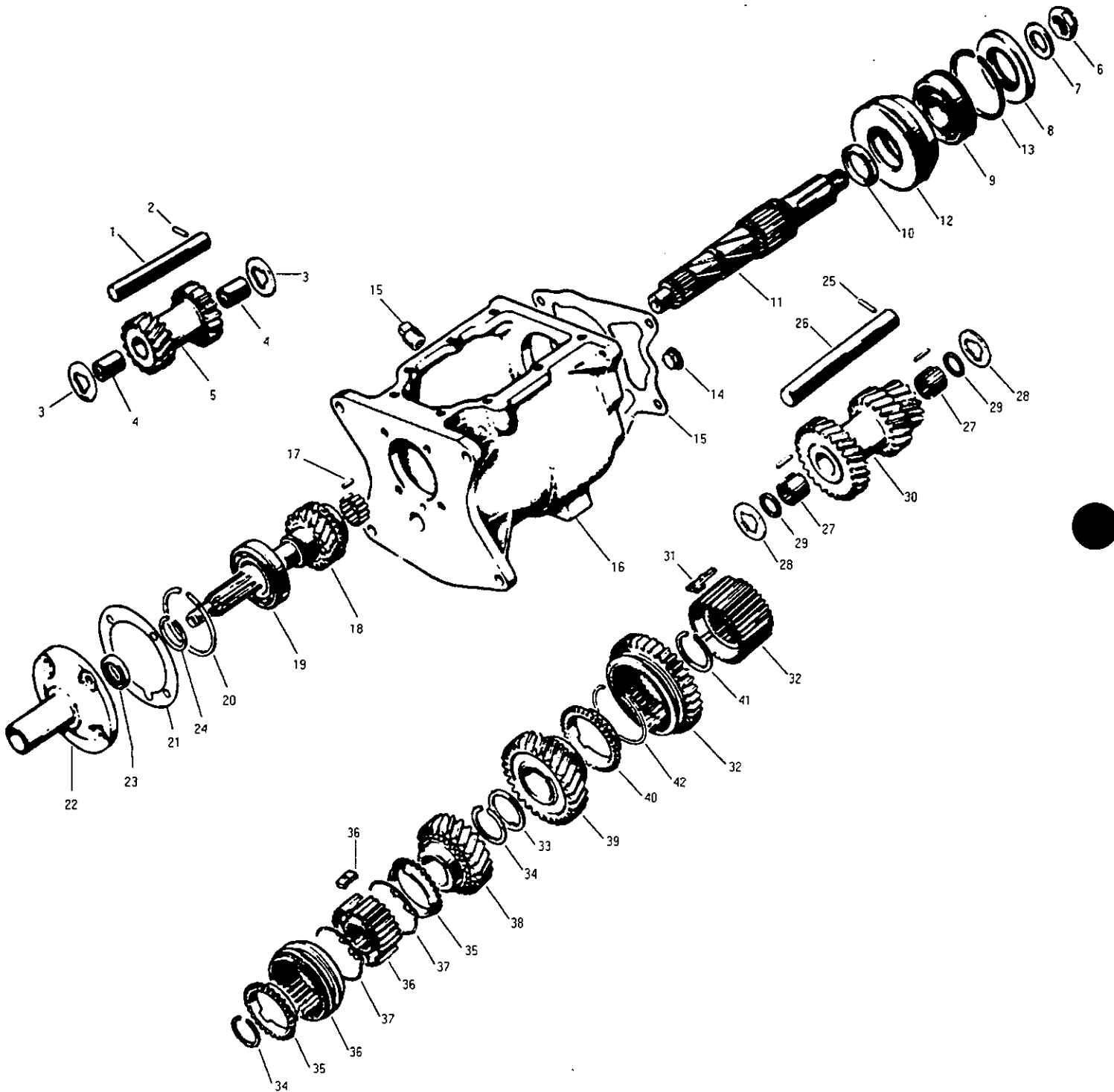

**T-150 TRANSMISSION**

<b>#</b>	<b>Part Number</b>	<b>Description</b>
1	J8124932	Pin, reverse idler gear
2	J8124912	Shaft, reverse idler gear
3	J8124915	Washer, reverse idler
4	J8124914	Bushing, reverse idler
5	J8124913	Reverse Idler Gear
6	J0940970	Nut, main shaft
7	J8126807	Washer, main shaft
8	J0938031	Seal, adapter plate
9	J8126834	Bearing, rear
10	J8126805	Bushing, main shaft
11	J8126804	Spline, main shaft
12	J8126810	76 Adapter, rear bearing
12	J8128879	77 Adapter, rear bearing
13	J8126813	Retaining Ring, rear bearing
14	J8126809	Plug, countershaft, rear
15	J0936615	Gasket
16	J8126808	Transmission Case 78-80 Spacer
17	J8124929	Roller Bearings
18	J8126106	Clutch Shaft, main drive gear
19	J8124933	Bearing, front
20	J8124882	Lock Ring, front
21	J8124853	Gasket, front bearing cap
22	J8124880	Bearing Cap, front
23	J8127391	Oil Seal, front
24	J8124883	Snap Ring, front
25	J8124931	Pin, Countershaft
26	J8124911	Countershaft, cluster gear
27	J8124908	Roller Bearings
28	J8124909	Thrust Washer, countershaft
29	J8124910	Washer, countershaft
30	J8124907	Cluster Gear, countershaft
31	J8124904	Plate, low & reverse
32	J8126234	Synchronizer Assy, low & reverse
33	J8124936	Thrust Washer, low gear
34	J8124935	Snap ring, low & high
35	J8124898	Friction Rings, 2nd & high
36	J8124895	Plate, 2nd & high
36	J8126235	Synchronizer Assy, low & high
37	J8124896	Retaining Sprng, 2nd & high
38	J8124899	Gear, 2nd
39	J8124902	Gear, low
40	J8124906	Friction Ring, low & reverse
41	J8124934	Snap Ring, low & reverse
42	J8124905	Retaining Spring, low & reverse
43	J8124939	Small Parts Kit
44	J8127216	Snap Ring Kit (all)

**T-18 TRANSMISSION**

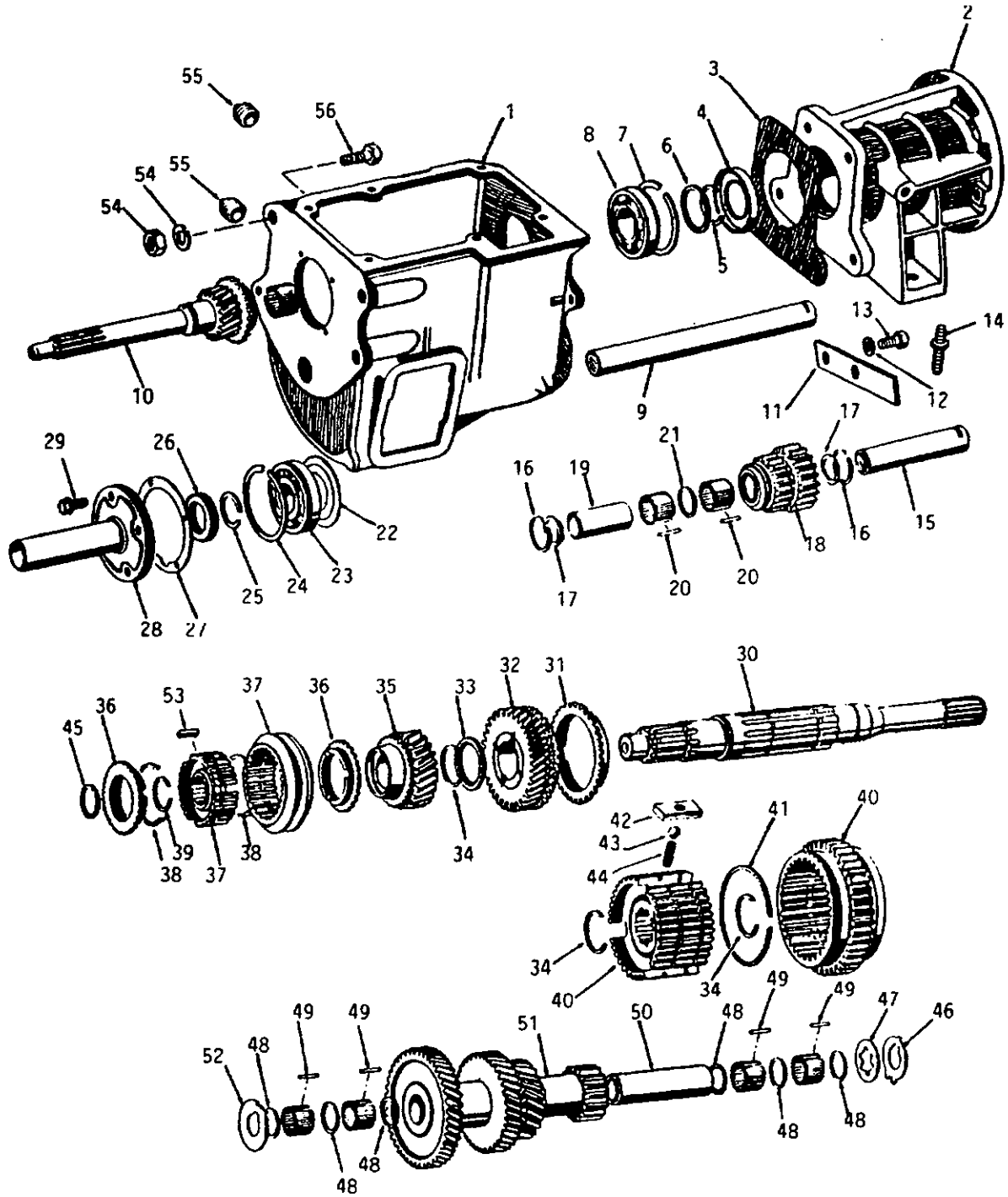

**T-18 FOUR SPEED TRANSMISSION**

REFERENCE NUMBER	DESCRIPTION	PART NUMBER	BEFORE 8/22/83	AFTER 8/22/83
1	CASE, Transmission	J8132648		
2	ADAPTER	J8132657		
3	GASKET	J8132658		
4	SEAL, Adapter oil	J8132957		
5	SNAP RING	J8132651		
6	WASHER, Thrust	J8132650		
7	RING, Bearing Lock	J0912342		
8	BEARING, Bear Ball	J0912341		
9	COUNTERSHAFT	J0940494		
10	SHAFT, Clutch	J8132656		
11	LOCKPLATE	J8132652		
12	WASHER, Lock	G138489		
13	BOLT	G180120		
14	STUD, Mounting	J4006461		
15	SHAFT, Reverse Idler	J0912359		
16	SNAP RING	J0912358		
17	WASHER, Thrust	J0012356		
18	GEAR, Reverse Idler	J0940503		
19	SLEEVE, Shaft	J0912357		
20	ROLLER BEARING	J0912354		
21	SPACER, Bearing	J0912355		
22	BAFFLE, Oil	J0640893		
23	BEARING, Clutch Shaft	J4488141		
24	SNAP RING	J0912342		
25	SNAP RING	J0912363		J0912366
26	SEAL, Front Bearing Oil	J8132779		
27	GASKET, Front Bearing Cap	J0912371		
28	CAP, Front Bearing	J8132654		
29	BOLT (x4)	G179817		
30	MAINSHAFT, Splined	J8132649		
31	RING, 1st & 2nd synchro	J0912340		83501860
32	GEAR, Second Speed	J0940498		
33	WASHER, Thrust	J0912332		
34	SNAP RING	J0912333		
35	GEAR, Third Speed	J8130254		
36	RING SET, 3rd & 4th synchro	J8130256		
37	CLUTCH ASSY, 3rd & 4th synch	J8130253		
38	SNAP RING	J8130257		
39	SNAP RING	J0912328		
40	CLUTCH ASSY	J0940499		83501858
41	RING, 1st & 2nd plate	J0912338		83501862
42	PLATE, 1st & 2nd synchro	J0912337		83501861
43	BALL, 1st & 2nd	G453593		
44	SPRING	J0917117		
45	SPACER	J0912346		
46	WASHER	J0939357		
47	WASHER	J0912350		
48	SPACER	J0912346		
49	ROLLER BEARING	J0912345		
50	SPACER	J0912347		
51	GEAR, countershaft	J0940502		
52	WASHER, Thrust	J0912348		
53	PLATE, 3rd & 4th synchro	J3182573		
54	WASHER	G120383, NUT - G271501		
55	PLUG, pipe	G444592		
56	BOLT	G9419081		

T  
R  
A  
N  
S

T-176, T-177 TRANSMISSION

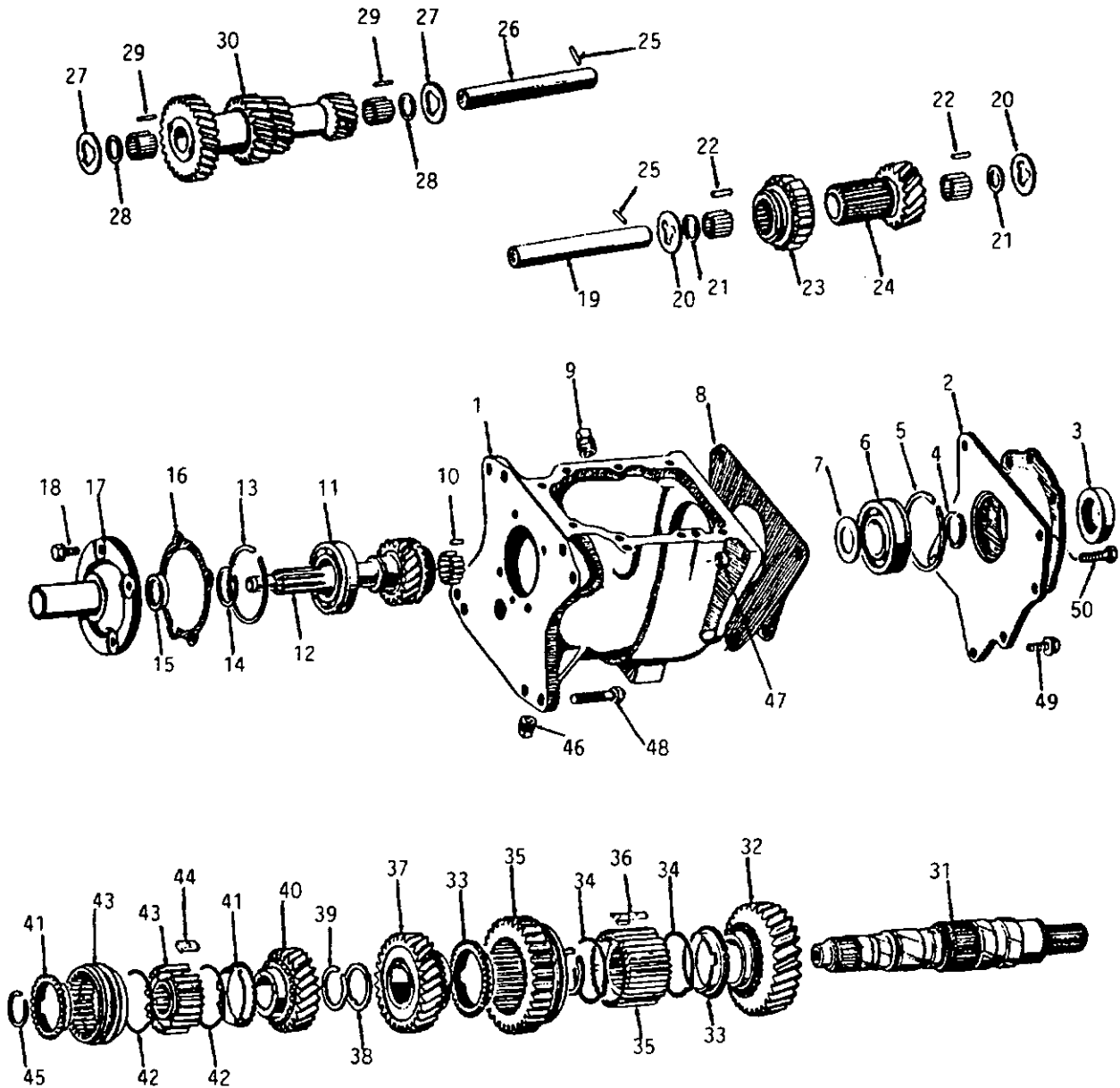

T-176, T-177 - FOUR SPEED TRANSMISSION

<u>REFERENCE NUMBER</u>	<u>DESCRIPTION</u>	<u>T-176</u>	<u>T-177</u>
1	CASE, transmission	J8132375	J8132375
2	ADAPTER	J5359381	J5359381
3	SEAL, adapter oil	J5359457	J5359457
4	SNAP RING	J8124883	J8124883
5	RING, rear bearing lock	J8132430	J8132430
6	BEARING, rear	J8132431	J8132431
7	WASHER, thrust	J8132390	J8132390
8	GASKET, trans to adapter	J5359411	J5359411
9	PLUG, drain or fill	G438159	G438159
10	ROLLER BEARING	J8124929	J8124929
11	BEARING, front	J8132426	J8132426
12	SHAFT, clutch	J8132369	J8132401
13	RING, front brg. lock	J8132425	J8132425
14	SNAP RING	J8132427	J8132427
15	SEAL, front brg. lock	J8124881	J8124881
16	GASKET, bearing cap	J8132423	J8132423
17	CAP, front bearing	J8132372	J8132372
18	BOLT (x4)	J8132424	J8132424
19	SHAFT, reverse idler	J8132398	J8132398
20	WASHER, thrust	J8132405	J8132405
21	WASHER, flat	J8132404	J8132404
22	ROLLER BEARING	J8132403	J8132403
23	GEAR, reverse sliding	J8132402	J8132402
24	GEAR, reverse idler	J8132399	J8132399
25	PIN, shaft	J8124931	J8124931
26	SHAFT, counter	J8132397	J8132397
27	WASHER, thrust	J8132396	J8132396
28	WASHER, FLAT	J8132395	J8132395
29	ROLLER BEARING	J8132394	J8132394
30	GEAR, countershaft	J8132391	J8132393
31	SHAFT, spline	J8132374	J8132374
32	GEAR, first speed	J8132389	J8132389
33	RING SET, 1st & 2nd sync	J8132378	J8132378
34	SPRING, 1st & 2nd sync	J8132377	J8132377
35	SYNCHRONIZER, 1st & 2nd	J8132386	J8132386
36	PLATE, 1st & 2nd sync	J8132387	J8132387
37	GEAR, second speed	J8132382	J8132384
38	WASHER, second gear	J8124936	J8124936
39	SNAP RING	J8132385	J8132385
40	GEAR, third speed	J8132379	J8132429
41	RING SET, 3rd & 4th synch	J8132378	J8132378
42	SPRING, 3rd & 4th synch	J8132377	J8132377
43	SYNCHRONIZER, 3rd & 4th	J8132376	J8132376
44	PLATE, 3rd & 4th synch	J8124895	J8124895
45	SNAP RING	J8124930	J8124930
46	PLUG, drain or fill	G438159	G438159
47	NUT	J4002256	J4002256
48	BOLT	G180147	G180147
49	BOLT	J4001884	J4001884
50	BOLT	G180137	G180137
51	SMALL PARTS KIT	SP170-50	SP170-50
52	GASKET & SEALS KIT	T-170-GS	T-170-GS

**SR4 TRANSMISSION**

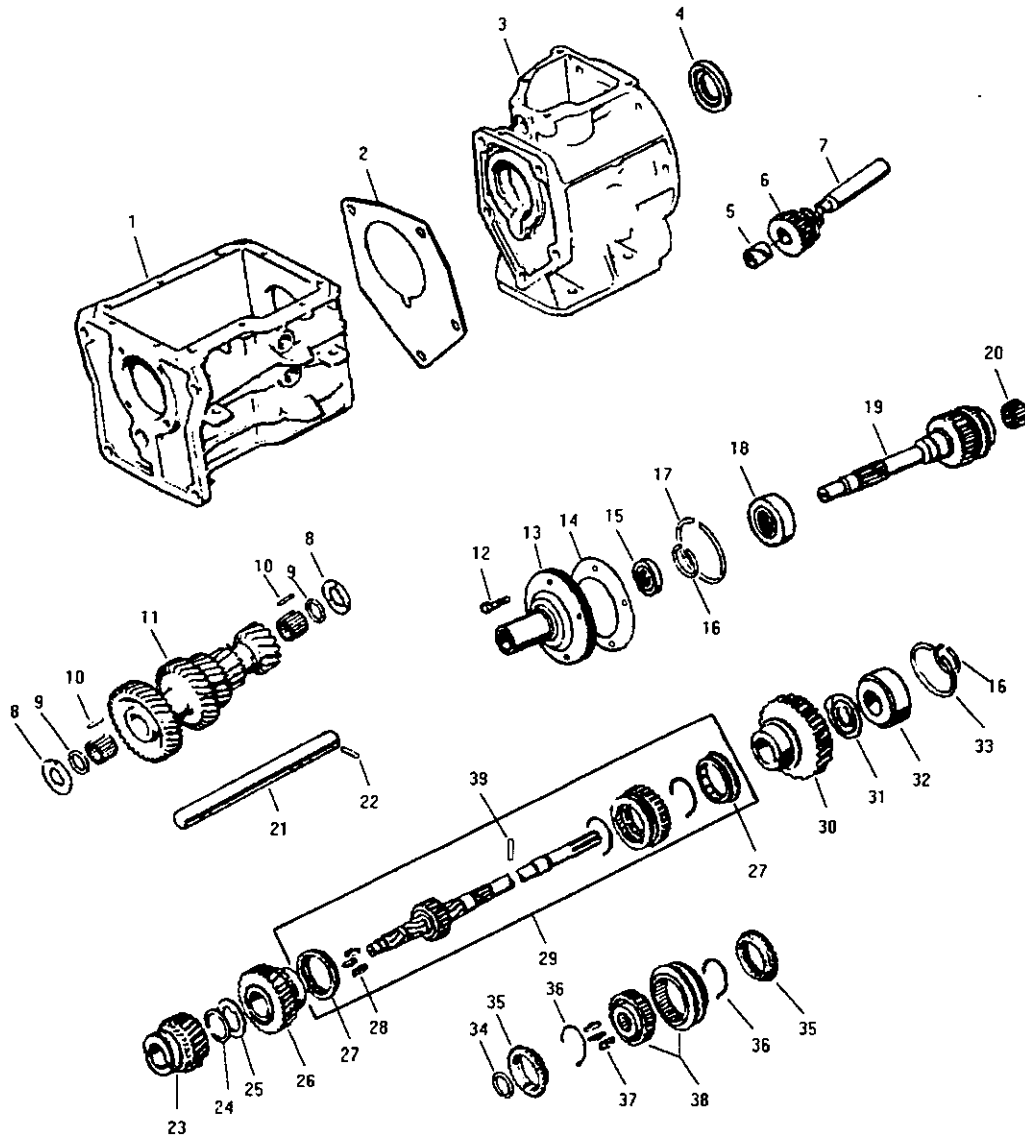



**SR-4 TRANSMISSION**

<b>#</b>	<b><u>Description</u></b>	<b><u>4 cylinder</u></b>	<b><u>6 cylinder</u></b>
	Transmission Assy	J3239675	J5360957
1	Case, transmission	J8132594	J8132594
2	Gasket, adapter	J8127385	J8127385
3	Adapter	J8133527	J8132671
4	Seal, adapter	J8132672	J8132672
5	Bushing, reverse idler	J8127464	J8127464
6	Gear, reverse idler	J8134230	J8134230
7	Shaft, reverse idler	J8133524	J8133524
8	Washer, thrust	J8127432	J8127432
9	Washer, flat	J8127429	J8127429
10	Roller, cluster gear (50)	J8127430	J8127430
11	Gear, cluster	J8132662	J8127428
12	Bolt, bearing retainer	J8127393	J8127393
13	Retainer, front bearing	J8127389	J8127389
14	Gasket, retainer	J8127392	J8127392
15	Seal, main drive gear	J8133528	J8127391
16	Snap Ring, bearing	J8127398	J8127398
17	Retaining Ring, bearing	J8127395	J8127395
18	Bearing, main drive gear	J8127394	J8127394
19	Main Drive Gear	J8132596	J8132597
20	Roller, main drive (15)	J8127397	J8127397
21	Counter Shaft	J8127433	J8127433
22	Pin, roll	J8127434	J8127434
23	Gear, 3rd	J8132674	J8127421
24	Snap Ring, 2nd	J8127424	J8127424
25	Washer, 2nd	J8127423	J8127423
26	Gear, 2nd	J8132675	J8127422
27	Blocking Ring Set	J8127403	J8127403
28	Plate, 1st & 2nd	J8127401	J8127401
29	Main Shaft Assy	J8133855	J8133855
30	Gear, 1st	J8127425	J8127425
31	Washer, 1st	J8127426	J8127426
32	Bearing, Rear	J8127407	J8127407
33	Retaining Ring, rear bearing	J8127395	J8127395
34	Snap Ring, 3rd & 4th	J8127420	J8127420
35	Blocking Ring Set, 3rd & 4th	J8127415	J8127415
36	Spring, synchronizer	J8127400	J8127400
37	Plate, synchronizer	J8127418	J8127418
38	Synchronizer, 3rd & 4th	J8127416	J8127416
39	Pin	J8127427	J8127427

T-4 TRANSMISSION

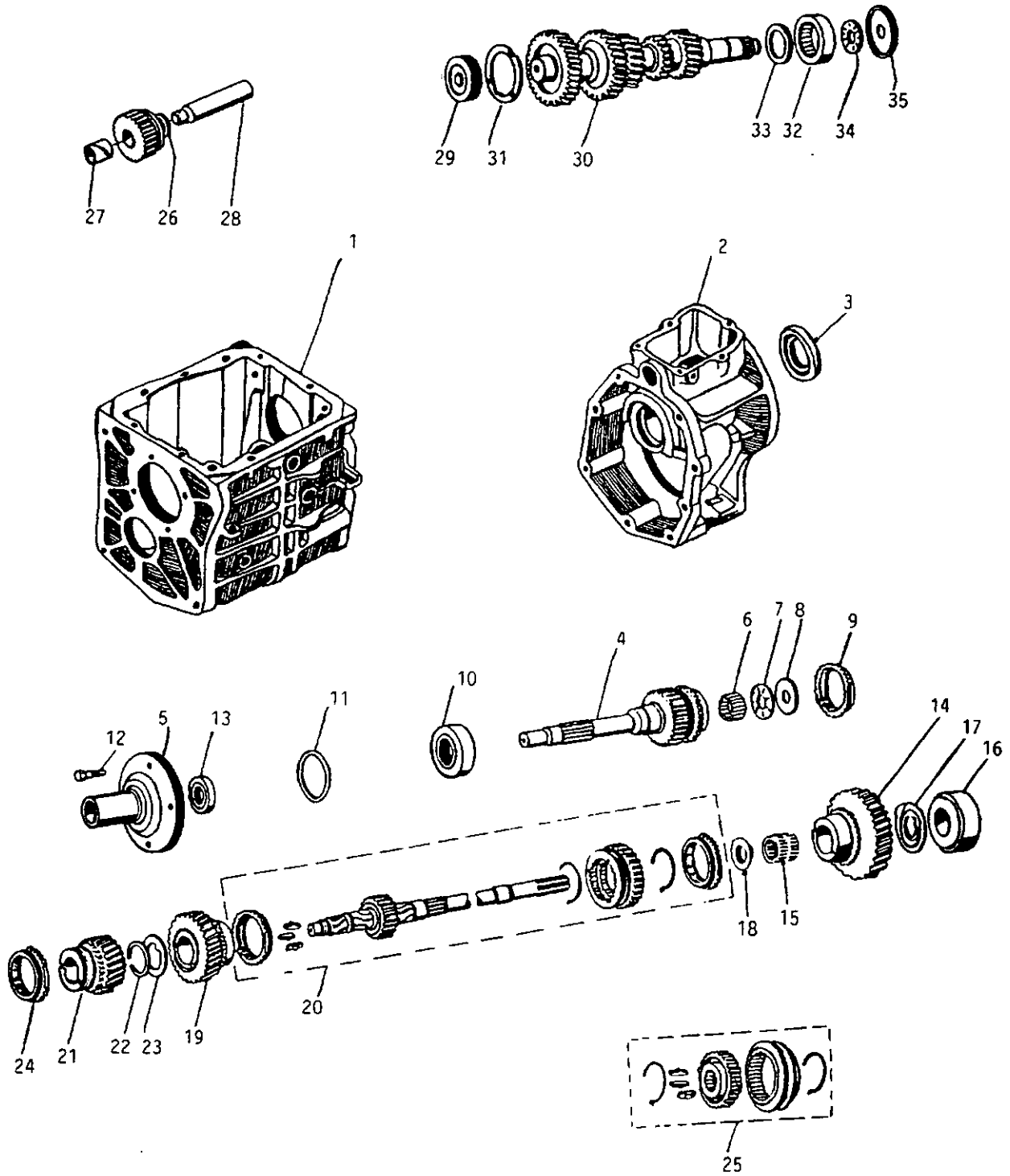

**T-4 Transmission**

<b># Description</b>	<b><u>10 Spline</u></b>	<b><u>14 spline</u></b>
TRANSMISSION ASSY	53001503 <sup>1</sup> 53001940 <sup>2</sup>	53001337 <sup>3</sup> 53001941 <sup>4</sup>
1 Case, transmission	J8134009 83500340	J8134009 83500340
2 Adapter, Transmission	83510185	83510185
3 Seal, Adapter	J8132672	J8132672
4 Shaft, input	83500975	83500968
5 Retainer	J8134013	J8134013
6 Roller Bearing	J8127397	J8127397
7 Bearing, thrust	J8134018	8134018
8 Race, thrust washer	J8124017	J8124017
9 Ring Set, blocking (x2)	J8134058	J8134058
10 Bearing	J8134015	J8134015
11 Shim Set (x8)	J8134016	J8134016
12 Screw (x4)	J8127393	J8127393
13 Seal	J8132779	J8132779
14 Gear, 1st	83501103 <sup>1</sup> 83500965 <sup>2</sup>	83501103 <sup>3</sup> 83500965 <sup>4</sup>
15 Bearing	83500969	83500969
16 Bearing	J8134030	J8134030
17 Washer, thrust	83500964	83500964
18 Race, thrust washer	83500962	83500962
19 Gear, 2nd	J8134024	J8134024
20 Mainshaft Assy.	83501166 <sup>1</sup> 83501944 <sup>2</sup>	83501166 <sup>3</sup> 83501944 <sup>4</sup>
21 Gear, 3rd (29 teeth) (27 teeth)	J8134026 83500380	J8134026 83500380
22 Snap Ring	J8127424	J8127424
23 Washer, thrust	J8134025	J8134025
24 Ring Set, blocking (2x)	J8134058	J8134058
25 Synch. Assy, 3rd & 4th	J8134027 <sup>1</sup> 83510192 <sup>2</sup>	J8134027 <sup>3</sup> 83510192 <sup>4</sup>
26 Gear, Reverse	J8134038	J8134038
27 Bushing	J8134336	J8134336
28 Shaft	J8134039	J8134039
29 Bearing	J8134033	J8134033
30 Gear, cluster (37-34 teeth) (37-32 teeth)	J8134031 83500970	J8134031 83500970
31 Washer, thrust	J8134032	J8134032
32 Bearing	J8134036	J8134036
33 Spacer	J8134035	J8134035
34 Bearing	J8134034	J8134034
35 Race, thrust washer	J8134037	J8134037

**T-5 TRANSMISSION**

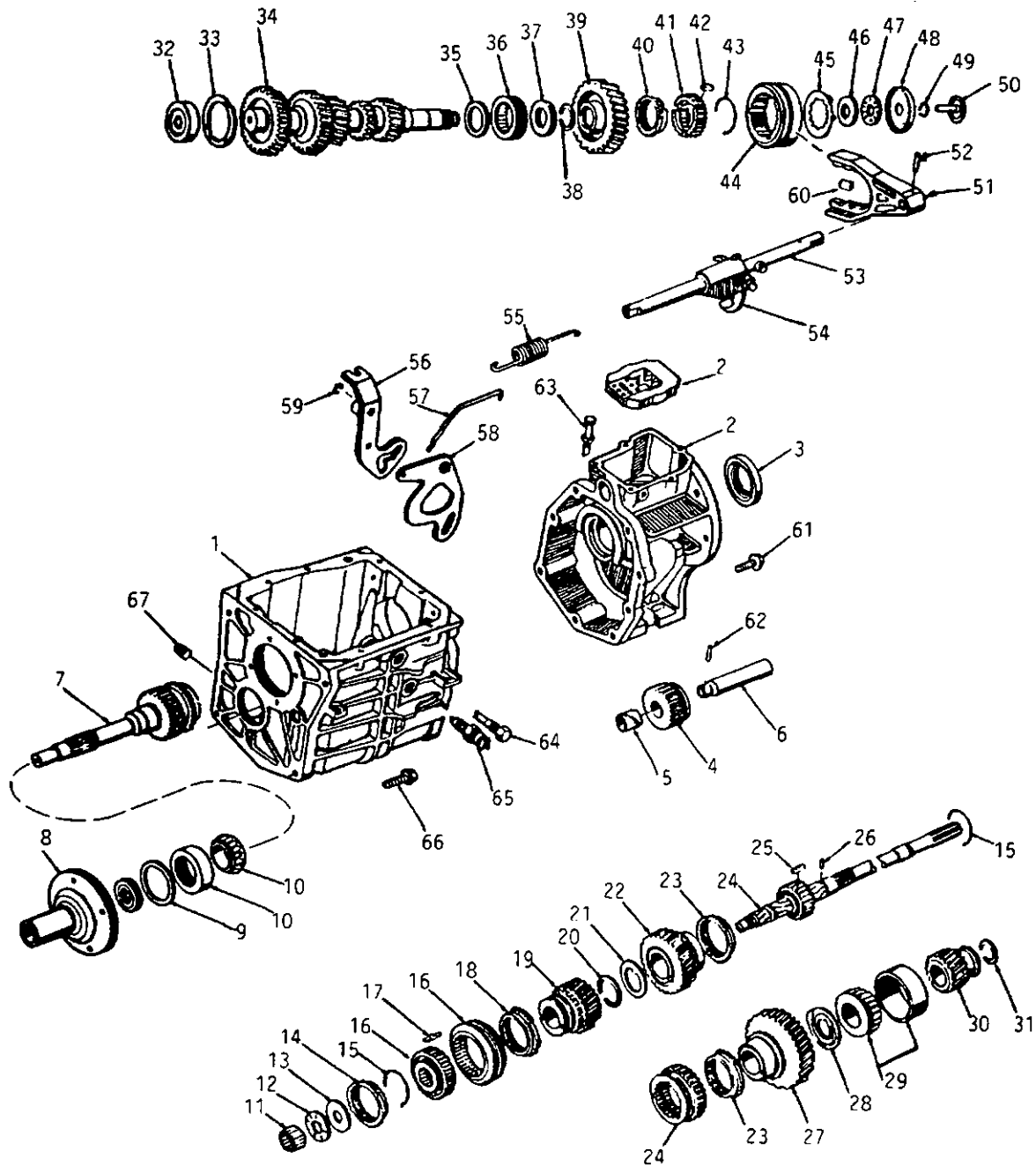

# GROUP 6: TRANSMISSION

CJ. WRANGLER

## I-5 Transmission

<u>Description</u>	<u>10 Spline</u>	<u>14 Spline</u>
TRANSMISSION ASSY	53001502 <sup>1</sup>	53001508 <sup>3</sup>
	53001945 <sup>2</sup>	53001946 <sup>4</sup>
1 Case, transmission	J8134093	J8134093
2 Adapter, w/oil seal	J8134095	J8134095
3 Seal, adapter	J8132672	J8132672
4 Gear, reverse idler	J8134038	J8134038
5 Bushing, reverse idler	J8134336	J8134336
6 Shaft, reverse idler	J8134039	J8134039
7 Shaft, input	83500975	83500968
8 Retainer	J8134013	J8134013
9 Shim Kit (x8)	J8134016	J8134016
10 Bearing, input shaft	J8134015	J8134015
11 Roller Bearing	J8127397	J8127397
12 Bearing, thrust	J8134018	J8134018
13 Race, thrust	J8134017	J8134017
14 Ring Set, 3rd & 4th synchro	J8134058	J8134058
15 Spring, synchro	J8134021	J8134021
16 Synchronizer Assy, 3rd & 4th	J8134027 <sup>1</sup>	J8134027 <sup>3</sup>
	83510192 <sup>2</sup>	83510192 <sup>4</sup>
17 Plate, synchro	J8127418	J8127418
18 Ring Set	J8134058	J8134058
19 Gear, 3rd speed (29 teeth)	J8134026	J8134026
(27 teeth)	83500380	83500380
20 Snap Ring	J8127424	J8127424
21 Washer, thrust	J8134025	J8134025
22 Gear, 2nd speed	J8134024	J8134024
23 Ring Set, 1st & 2nd synchro	J8127403	J8127403
24 Mainshaft Assy	83501166 <sup>1</sup>	83501166 <sup>3</sup>
	83501994 <sup>2</sup>	83501994 <sup>4</sup>
25 Plate, synchro	J8127401	J8127401
26 Pin (1/8" - 3/8")	J8127427	J8127427
27 Gear, 1st speed	83501103 <sup>1</sup>	83501103 <sup>3</sup>
	83500965 <sup>2</sup>	83500965 <sup>4</sup>
28 Washer, thrust	J8134023	J8134023
29 Bearing, rear	J8134030	J8134030
30 Gear, 5th speed driven	J8134080	J8134081
31 Snap Ring	J8134082	J8134082
32 Bearing, roller	J8134071	J8134071
33 Washer, thrust	J8134070	J8134070
34 Gear, cluster (37-34 teeth)	J8134069	J8134069
(37-32 teeth)	83500967	83500967
35 Spacer	J8134035	J8134035
36 Bearing, roller	J8134036	J8134036
37 Spacer	J8134072	J8134072
38 Snap Ring	J8134073	J8134073
39 Gear, 5th speed drive	J8134083	J8134084
40 Ring, 5th speed	J8127415	J8127415
41 Synchronizer Assy, 5th	J8134086	J8134086
42 Plate, synchro	J8127418	J8127418
43 Spring, synchro	J8127419	J8127419
44 Clutch Assy, 5th speed	J8134086	J8134086
45 Retainer, strut	J8134087	J8134087
46 Race, thrust	J8134088	J8134088
47 Bearing, thrust	J8134034	J8134034
48 Race, thrust	J8134037	J8134037
49 Snap Ring	J8134089	J8134089
50 Funnel	J8134090	J8134090
51 Fork, 5th speed	J8134085	J8134085
52 Pin (3/16" x 1")	J8134040	J8134040
53 Rail Assy	J8134079	J8134079
54 Fork Assy, reverse	83500284	83500284
55 Spring, reverse lock	J8134076	J8134076
56 Lever, 5th speed	J8134075	J8134075
57 Hook, reverse lock	J8134077	J8134077
58 Plate, reverse lock	J8134078	J8134078
59 Ring, Retainer	J8127469	J8127469
60 Insert	J8133418	J8133418
61 Bolt	J8134098	J8134098
62 Pin (3/16" x 1")	J8134040	J8134040
63 Breather	J0912375	J0912375
64 Pin, pivot	J8134041	J8134041
65 Switch, backup light	J8134068	J8134068
66 Bolt	J4006682	J4006682
67 Plug, pipe	J8128343	J8128343

**AX5, AX15 TRANSMISSION**

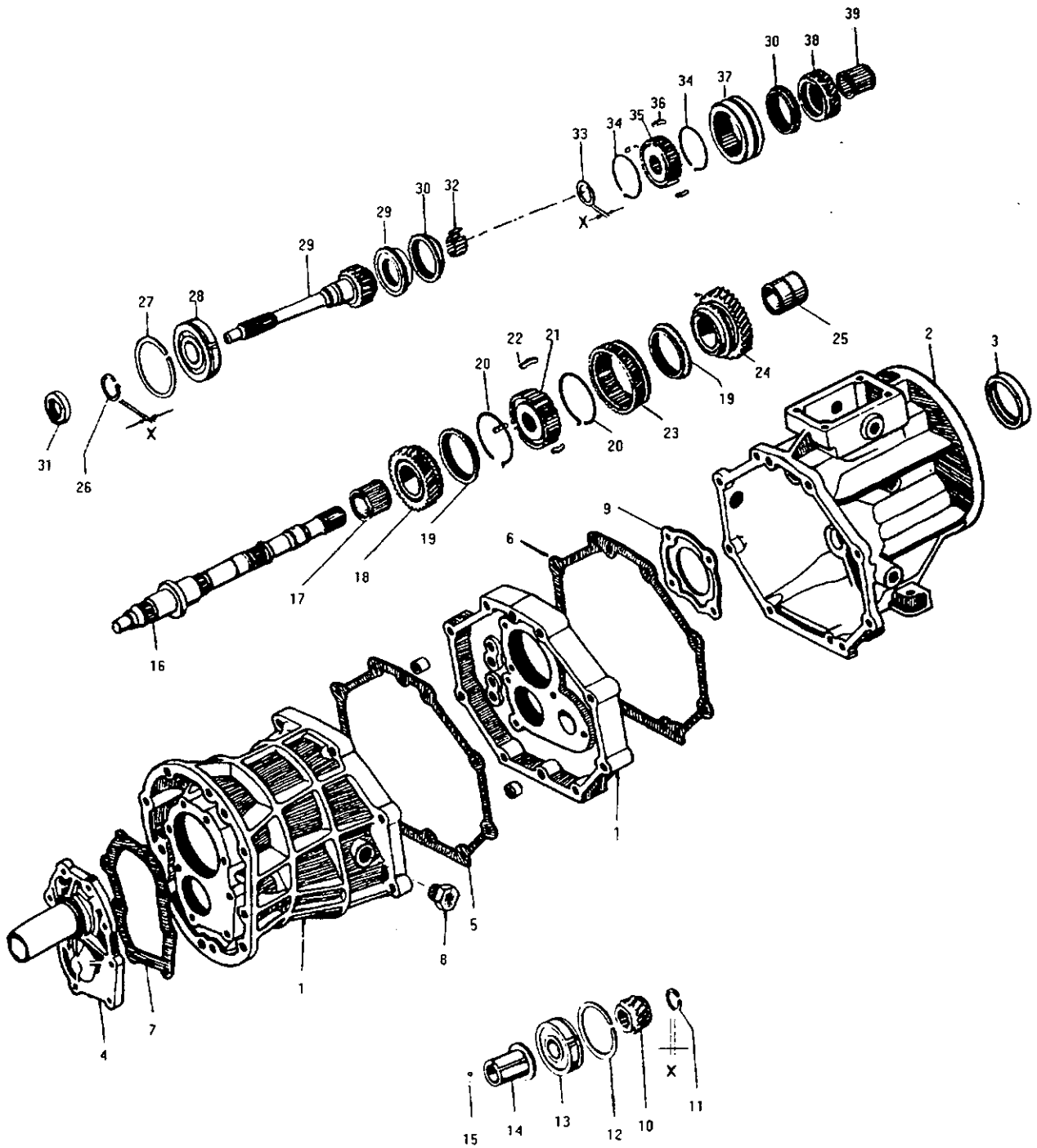

**AX5 - AX15 TRANSMISSION**

<b># Description</b>	<b>4cyl. to 10/4/88</b>	<b>4 cyl. after 10/4/88</b>		<b>6 cyl. after 3/3/89</b>
<b>TRANSMISSION ASSY</b>	<b>53004224</b>	<b>53006176</b>		<b>53005360</b>
1 Case, transmission	83500634	83506016		J5252034
2 Adapter, transmission	83503111	83506039		83506224
3 Seal, Adapter	83503108	83503108		83503108
4 Retainer	83502112	83503112		J5252052
5 Gasket, transmission	83500506	83500506		-----
6 Gasket, adapter	83500507	83500507		-----
7 Gasket, retainer	83500505	83500505		-----
8 Plug	83500508	83500508		83500512
9 Retainer	83500508	83506034		J5252036
10 Gear, 5th	83500971	83500971		J5252083
11 Snap Ring:				
x=2.67 mm	83500587	83500587	x=2.75 mm	83506268
x=2.73 mm	83500588	83500588	x=2.80 mm	83506269
x=2.79 mm	83500589	83500589	x=2.85 mm	83506270
x=2.85 mm	83500590	83500590	x=2.90 mm	83506271
x=2.91 mm	83500591	83500591	x=2.95 mm	83506272
x=2.97 mm	83500592	83500592	x=3.00 mm	83506273
x=3.03 mm	83500593	83500593	x=3.05 mm	83506274
x=3.09 mm	83500594	83500594	x=3.10 mm	83506275
x=3.15 mm	83500595	83500595	x=3.15 mm	83506276
x=3.21 mm	83500596	83500596	x=3.20 mm	83506277
x=3.27 mm	83500596	83500596	x=3.25 mm	83506278
			x=3.30 mm	83506279
				-----
12 Snap Ring	83500613	83500613		
13 Bearing	83500575	83500575		83506074
14 Race	83500560	83500560		-----
15 Ball, reverse	83500573	83500573		83500573
16 Shaft, output	83503105	83503105		83506243
17 Bearing	83500577	83500577		83506076
18 Gear, 2nd	83500551	83500551		J5252078
19 Ring, synchronizer (x2)	83500567	83500567		83506252
20 Spring, synchronizer (x2)	83500569	83500569		83506254
21 Synchronizer, 1st & 2nd g	83500561	83500561		83506247
22 Key, synchronizer	83500564	83500564		83506250
23 Gear, reverse	83500555	83500555		J5252082
24 Gear, 1st	83500550	83500550		J5252077
25 Bearing	83500578	83500578		83506280
26 Snap Ring:				
x=2.05 mm	83500645	83500645	x=2.10 mm	83506099
x=2.10 mm	83500607	83500607	x=2.15 mm	83506214
x=2.15 mm	83500608	83500608	x=2.20 mm	83506215
x=2.20 mm	83500609	83500609	x=2.25 mm	83506216
x=2.25 mm	83500610	83500610	x=2.30 mm	83506217
x=2.30 mm	83500611	83500611	x=2.35 mm	83506218
			x=2.40 mm	83506219
				83506222
27 Snap Ring	83500614	83500614		
28 Bearing	83502681	83502681		83506073
29 Shaft, input	83502682	83502682		J5252081
30 Ring, synchronizer	83500566	83500566		83506253
31 Seal	83500501	83500501		J5252053
32 Roller (x13)	83502680	83502680		83506078
33 Snap Ring:				
x=1.75 mm	83500598	83500598	x=1.80 mm	83506086
x=1.80 mm	83500599	83500599	x=1.85 mm	83506087
x=1.85 mm	83500602	83500602	x=1.90 mm	83506088
x=1.90 mm	83500603	83500603	x=1.95 mm	83506089
x=1.95 mm	83500604	83500604	x=2.00 mm	83506090
x=2.00 mm	83500605	83500605	x=2.05 mm	83506091
x=2.05 mm	83500606	83500606	x=2.10 mm	83506092
34 Spring, synchronizer	83500568	83500568		83506255
35 Synchronizer, 3rd & 4th gear	83500562	83500562		83506248
36 Key, Synchronizer	83500565	83500565		83506251
37 Sleeve, synchronizer	83500563	83500563		83506249
38 Gear, 3rd	83500552	83500552		J5252079
39 Bearing	83500576	83500576		83506077

**T  
R  
A  
N  
S**

**BA10/5 TRANSMISSION**

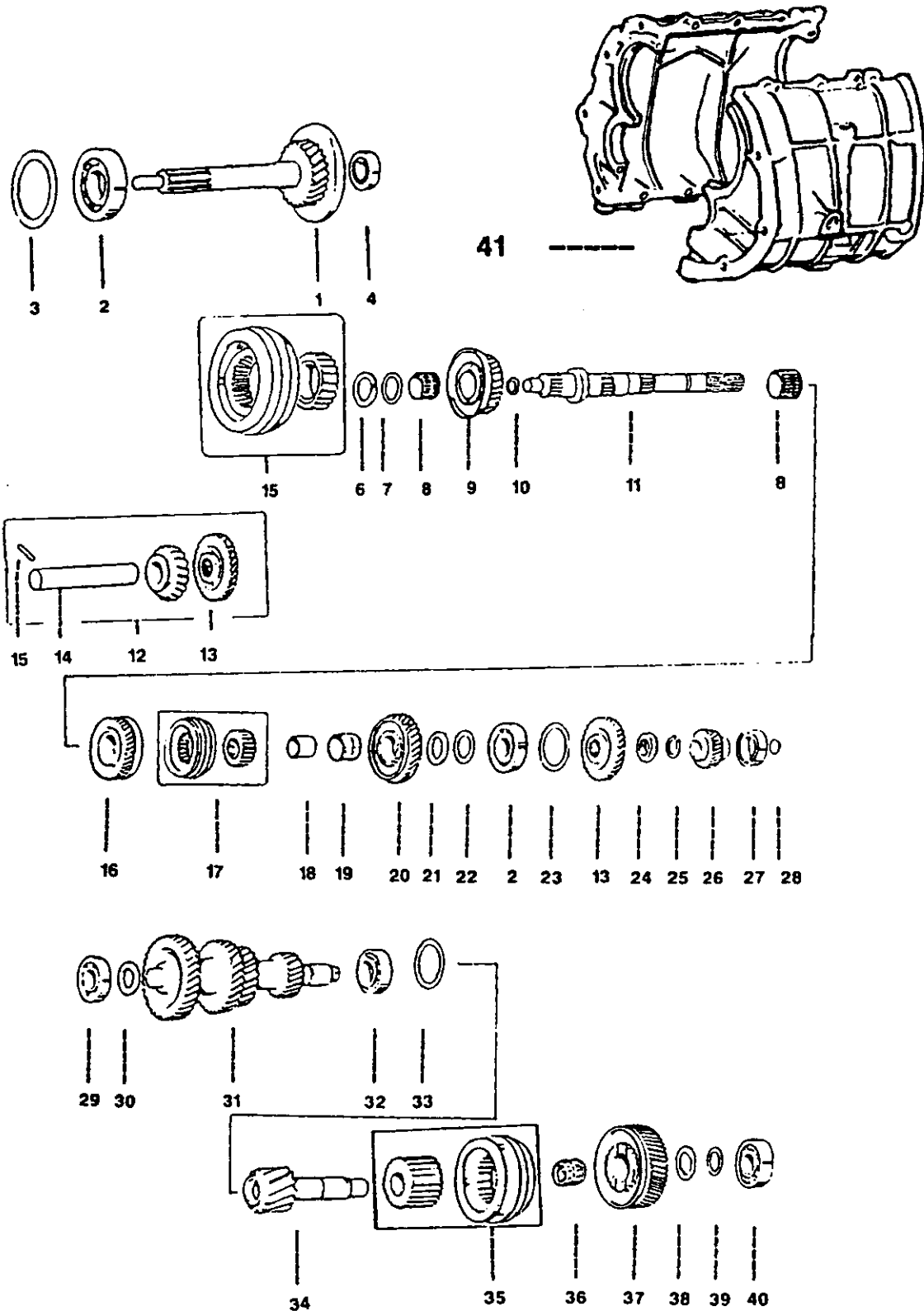



**BA 10/5 TRANSMISSION**

<b># Description</b>	<b>With Tag # Up to 131001</b>	<b>With Tag # Over 131002</b>
<b>TRANSMISSION ASSY.</b>	<b>53002035</b>	<b>53005451</b>
1 Gear, main drive	83503229 <sup>A</sup>	83505205
2 Bearing	83503212	83505447
3 Shim Kit	83503230	83503230
4 Bearing	83504410	83504410
5 Synchronizer, 3rd & 4th gear	83504103	83504103
6 Ring	83503203	83503203
7 Washer	83504870	835044870
8 Bearing, roller	83503208	83503208
9 Gear, 3rd	83503221	83503221
10 Washer, spring	83503205	83503205
11 Main shaft	83503219	83503219
12 Gear Kit, reverse	83504500	83504500
13 Gear, reverse	83503206	83503206
14 Rail, reverse	83503248 <sup>B</sup>	83503262
15 Pin, reverse	83503257	83503257
16 Gear, 2nd	83503208	83503208
17 Synchronizer, 1st & 2nd gear	83504089	83504089
18 Spacer	83503213	83503213
19 Bearing, roller	83503231	83503231
20 Gear, 1st	83503214 (12x34T)	83505444 (12x32T)
21 Shim	83504622	83504622
22 shim set	83503222	83503222
23 Ring, retaining	83505477	83505477
24 Nut	83503204	83503204
25 Ring, locking	83503253	83503253
26 Gear, 5th	83504099 (53x27T)	83505452 (51X28T)
27 Bearing	83503249	83503249
28 Ring, retaining	83503224	83503224
29 Bearing	83503209	83503209
30 Shim Set	83503254	83503254
31 Gear, cluster	83503239	83505445
32 Bearing	83503217	83505448
33 Ring, retaining		83505478
34 Gear, 5th intermediate	83503242	83503242
35 Synchronizer, 5th gear	83503246	83503246
36 Bearing	83503207	83503207
37 Gear, 5th intermediate	83503243 (53x27T)	83505451 (51X28T)
38 Shim	83503247	83503247
39 Shim Set	83503237	83503237
40 Bearing	83503201	83503201
41 Case	83503281 <sup>C</sup>	83505568

**A.** Used up until transmission tag# 71787, later models use 83505205.

**B.** Used up until transmission tag# 12615, later models use 83503262.

**C.** Used up until transmission tag# 71788, tag#'s 71789 through 131001 use 83505274

**MODEL 207 & 231 TRANSFER CASE**

231

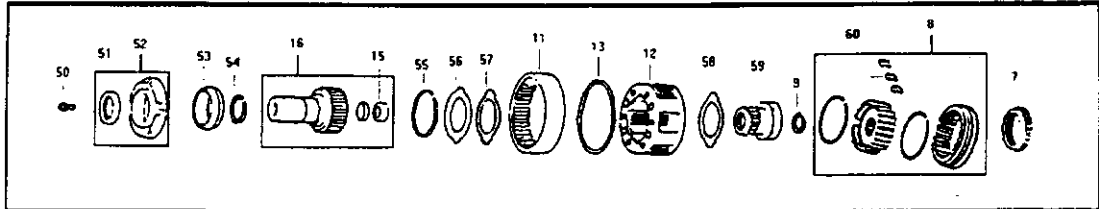

207

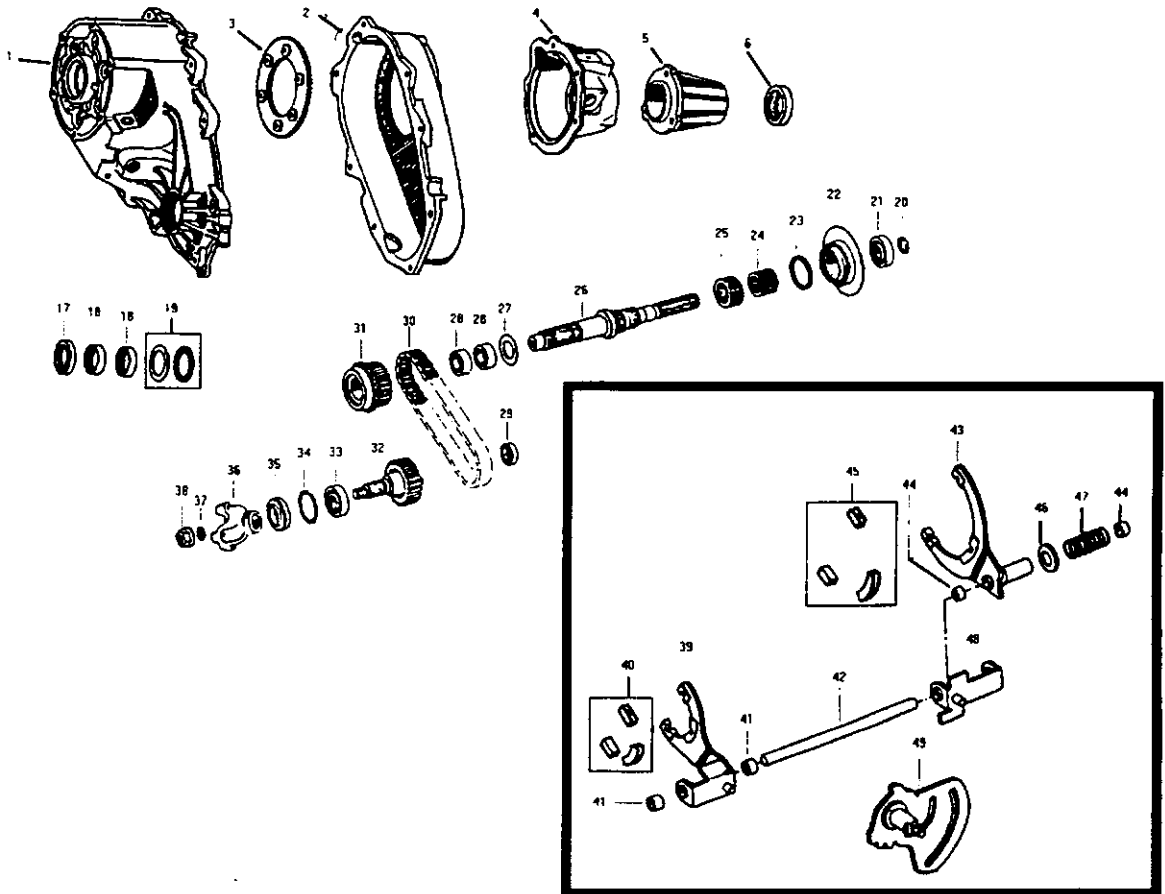
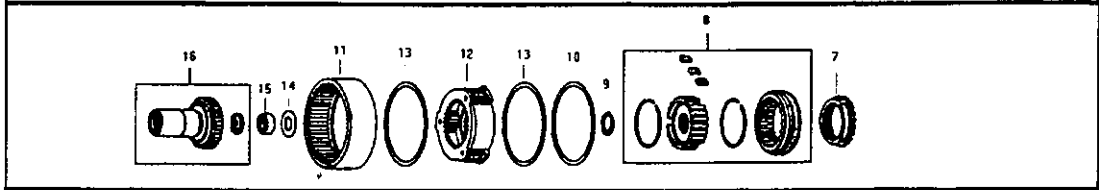

**MODEL 207 & 231 TRANSFER CASE**

<b># Description</b>	<b>Model 207</b>	<b>Model 231</b>
1 Case, front	83500953	83503572
2 Case, rear	83501192	83503153
3 Plate	J8130873	-----
4 Retainer	J8134487	83503573
5 Extension, case	J8134489	83503156
6 Seal	83501389	83501389
7 Ring, stop	83500992	83503142
8 Synchronizer, mode shif	J8134480	83503143
9 Ring, retaining	J8134481	83503144
10 Ring, retaining	J8134454	-----
11 Gear, annulus	J8134452	83503122
12 Gear, planetary	J8134455	83503129
13 Ring, thrust	J8134456	J8134454
14 Washer, thrust	83500993	-----
15 Bearing	J8134450	J8134450
16 Gear, input	J8134495	83503159
	83502830	83503158
17 Seal, oil	J5359457	J5359457
18 Bearing	J8134444	-----
19 Bearing Kit	J8134451	-----
20 Ring	J8134488	J8134488
21 Bearing	J8134445	J8134445
22 Housing, oil pump	J8134486	83503148
23 Seal, oil	J8130982	J8130982
24 Gear, speedometer drive	J8134493	-----
	83502828	-----
25 Pump, oil	J8133645	-----
26 Shaft, main drive	J8134467	83503141
27 Washer, thrust	J8134470	-----
28 Bearing	J8134469	J8130868
29 Bearing	J8134484	83503154
30 Chain, drive	J8134471	83503146
31 Sprocket, drive	J8134468	83503142
32 Shaft, output	J8134482	83503145
33 Bearing	J8124445	J8134445
34 Ring, retaining	J8134447	J8134447
35 Seal, oil	J8134446	83503147
36 Flange	83502829	83502829
37 Washer	J8134474	J8134474
38 Nut	J8134475	J8134475
39 Fork, range shift	J8134459	83503136
40 Pad Kit, shift fork	83500994	83500994
41 Bushing	J8134460	83503137
42 Rail, shift	J8134466	-----
43 Fork, mode shift	J8134461	83503138 <sup>1</sup>
44 Bushing	J8134465	-----
45 Pad Kit, shift fork	J8134279	J8134279
46 Cup	J8134464	-----
47 Spring	J8134463	83503140
48 Bracket, shift	J8134462	-----
49 Sector/shaft	J8134457	83503124
50 Bolt		83503135
51 Retainer Kit		83503133
52 Bearing		83503123
53 Snap Ring		83503131
54 Snap Ring		83503527
55 Snap Ring		83503526
56 Key		83500990
57 Thrust Ring		83503130
58 Sleeve		83503132

<sup>1</sup> Includes Rail.

**MODEL 300 TRANSFER CASE**

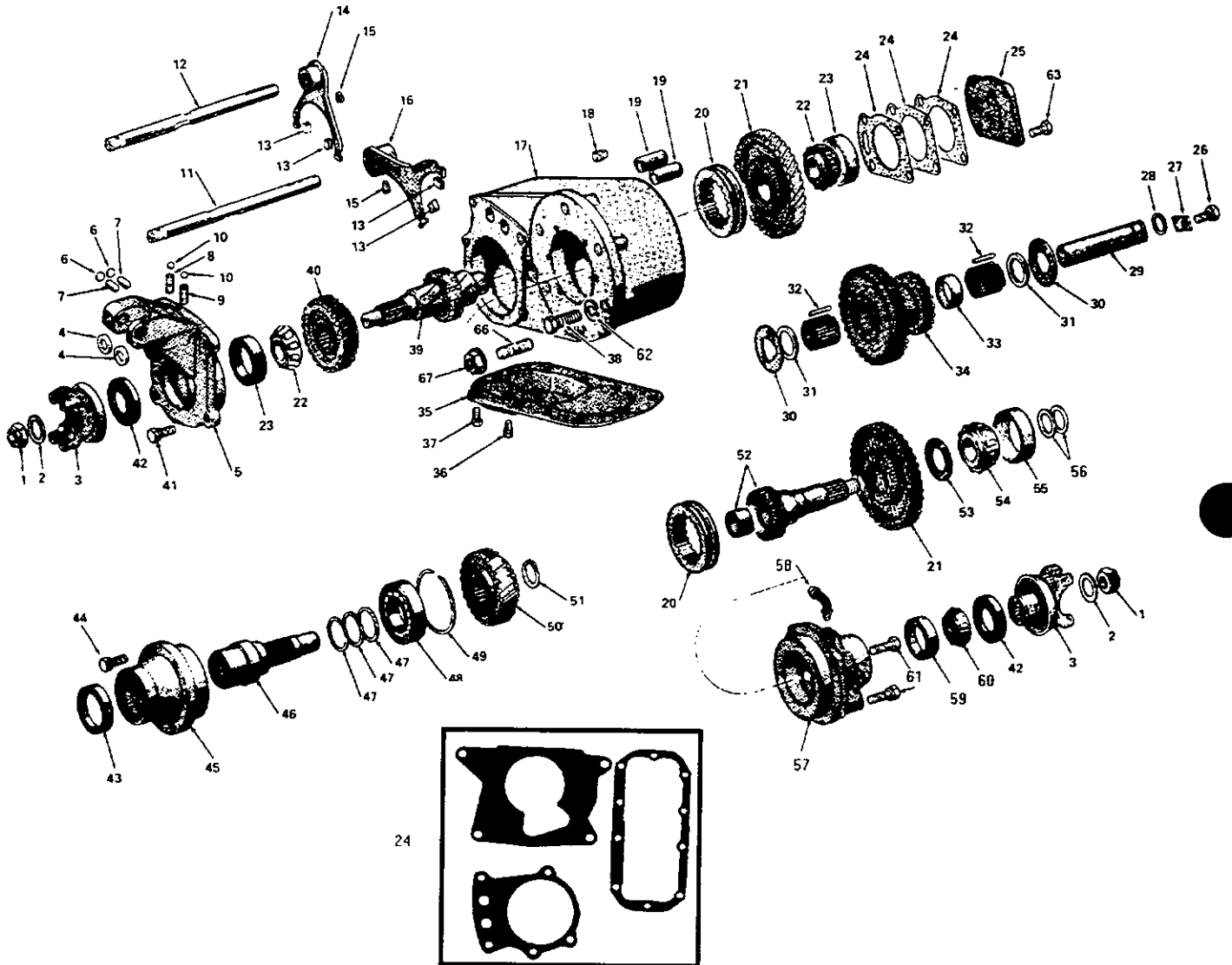

**MODEL 300 TRANSFER CASE**

#	Description	Part Number
1	Nut, output shaft	J0801367
2	Washer, output shaft	J4004917
3	Yoke Assy, output	J8131656
4	Seal, shift rod oil	J8131674
5	Cap, front output bearing	J8131671
6	Plug, interlock	J8131677
7	Interlock	JA000965
8	Spring, shift rod poppet	J8131676
9	Spring, shift rod poppet	J8131675
10	Ball, shift rod poppet	G453593
11	Rod, shift	J8131692
12	Rod, shift	J8131673
13	Clip, shift fork	J8131670
14	Fork, shift	J8131665
15	Screw, shift fork	J0935727
16	Fork, shift	J8131666
17	Case, transfer	J8133466
18	Plug, fill	G444831
19	Thimble, shift fork rod	J0934281
20	Collar, clutch	J8131667
21	Gear, sliding drive	J8131679
22	Cone, bearing	J3156063
23	Cup, bearing	J3156062
24	Shim Kit, including gaskets	D300-GS
25	Cover, front output	J8131657
26	Bolt, lockplate	J0942185
27	Lockplate	JA001001
28	Seal, intermediate shaft	J0942114
29	Shaft, intermediate	J0942115
30	Washer, thrust	J8121813
31	Spacer, intermediate bearing	J0809295
32	Bearing, needle	J0809294
33	Spacer, bearing	J8131661
34	Gear, intermediate	J8131678
35	Cover, case	J8131663
36	Plug, drain	J8131664
37	Screw, case lower	J0937298
38	Bolt	G180124
39	Shaft, front output	J8131660
40	Gear, front output	J8131680
41	Screw, front bearing cap	J0937304
42	Seal, oil	J8131669
43	Seal, input oil	J8131684
44	Screw, input retainer	J8132677
45	Retainer, input bearing	J8131681
46	Shaft, input	J8131687
47	Shim Kit, input shaft	J8131689
48	Bearing, input	J8131682
49	Ring, bearing snap	J8131683
50	Gear, input	J8131685
51	Ring, input gear snap	J8131686
52	Shaft, rear output	J8131688
53	Spacer, output shaft	J8131662
54	Cone, rear output inner bearing	J0052799
55	Cup, rear output inner bearing	J0052800
56	Shim Kit, rear output bearing	J0933743
57	Cap, rear output bearing	J8131658
58	Breather	J8131659
59	Cup, rear output bearing outer	J3124570
60	Cone, rear output bearing outer	J0933737
61	Bolt, rear output cap	J0998593
62	Washer, lock	J0649704
63	Stud	J5455303
64	Nut & Washer Assy	G271193

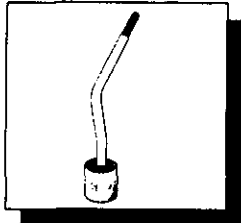

7.001

**LEVER, Floor Gear Shift**

4 Cyl : CJ, 1980-81 (SR4)  
use J5361262  
4 Cyl : CJ, 1982-83 (T176, 177)  
use J5359836  
4 Cyl : CJ, 1983-86 (T4, T5)  
use J5364641  
4 Cyl : Wr, 1987-89 (Asian)  
use 83503110

6 Cyl : CJ, 1979 (T150)  
use J5359315  
6 Cyl : CJ, 1979 (T18)  
use J5358100  
6 Cyl : CJ, 1980 (SR4)  
use J5361262  
6 Cyl : CJ, 1981-86 (T176, 177)  
use J5359835  
6 Cyl : CJ, 1982-86 (T4, T5)  
use J5363538  
6 Cyl : Wr, 1987-89 (Peugeot)  
use 83503274

8 Cyl : CJ, 1979 (T18)  
use J5358100  
8 Cyl : CJ, 1980-81 (T176, 177)  
use J5359835

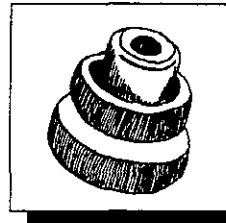

7.013

**COVER, Floor Gear Shift Lever  
T176, T18**

4 Cyl : CJ, 1980-83 use J8132422  
  
6 Cyl : CJ, 1979 use J0948185  
6 Cyl : CJ, 1981-86 use J8132422  
  
8 Cyl : CJ, 1979 use J0948185  
8 Cyl : CJ, 1980-81 use J8132422



7.013

**BOOT, Floor Gear Shift Lever  
With Manual Transmission**

4 Cyl : CJ, 1980-86 use J5752010  
4 Cyl : Wr, 1987-89 use 83500520  
  
6 Cyl : CJ, 1980-86 use J5752010  
6 Cyl : Wr, 1987-89 use 83503279  
  
8 Cyl : CJ, 1980-81 use J5752010

NOTE: 1. FROM TRANSMISSION #12616 AND ON  
USE 83504621.

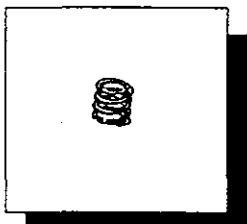

7.001

**SPRING, Floor Gear Shift Lever  
Fulcrum - T176, T150**

4 Cyl : CJ, 1980-84 use J8127059  
  
6 Cyl : CJ, 1979 use J0801732  
6 Cyl : CJ, 1979-84 use J8127059  
  
8 Cyl : CJ, 1979 use J0801732  
8 Cyl : CJ, 1979-81 use J8127059

NOTE: 1. FOR 4 SPEED.

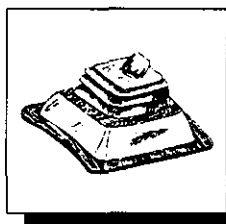

7.013

**BOOT, Transmission and Transfer  
Shift Lever**

4 Cyl : CJ, 1980-86 use J5752141  
  
6 Cyl : CJ, 1980-86 use J5752141  
  
8 Cyl : CJ, 1979-81 use J5752141



7.001

**RETAINER, Floor Gear Shift Lever  
Fulcrum Spring - T176, T18**

4 Cyl : CJ, 1980-83 use J8132420  
  
6 Cyl : CJ, 1979 use J0912379  
6 Cyl : CJ, 1981-86 use J8132420  
  
8 Cyl : CJ, 1979 use J0912379  
8 Cyl : CJ, 1980-81 use J8132420

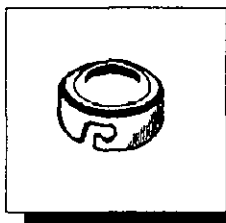

7.013

**CAP, Transmission Control Housing  
T176, T18**

4 Cyl : CJ, 1980-83 use J8132421  
  
6 Cyl : CJ, 1979 use J0912380  
6 Cyl : CJ, 1981-86 use J8132421  
  
8 Cyl : CJ, 1979 use J0912380  
8 Cyl : CJ, 1980-81 use J8132421

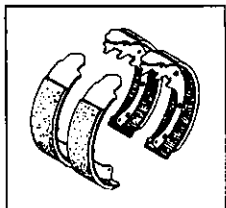

8.004

**SHOE SET, Rear Brake**

Set of 4 Shoes with Lining

4 Cyl : CJ, 1980-86 use J8130301  
4 Cyl : Wr, 1987-89 use J8133818

6 Cyl : CJ, 1979-86 use J8130301  
6 Cyl : Wr, 1987-89 use J8133818

8 Cyl : CJ, 1979-81 use J8130301

NOTE: 1. WITH DANA MODEL 44 AXLE USE 83502385.

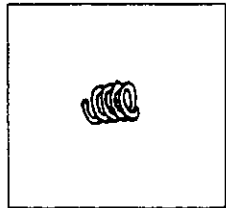

8.008

**SPRING, Parking Brake Lever Strut**

4 Cyl : CJ, 1980-86 use J3112779  
4 Cyl : Wr, 1987-89 use J3112779

6 Cyl : CJ, 1979-86 use J3112779  
6 Cyl : Wr, 1987-89 use J3112779

8 Cyl : CJ, 1979-81 use J3112779

NOTE:

1. WITH DANA MODEL 44 AXLE USE 83504310.

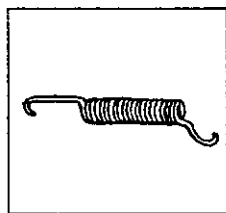

8.008

**SPRING, Brake Shoe Return - Upper**

4 Cyl : CJ, 1980-86 use J3112780  
4 Cyl : Wr, 1987-89 use J3112780

6 Cyl : CJ, 1979-86 use J3112780  
6 Cyl : Wr, 1987-89 use J3112780

8 Cyl : CJ, 1979-81 use J3112780

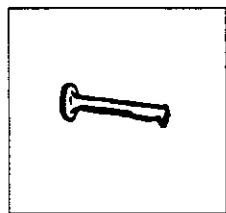

8.008

**PIN, Brake Shoe Hold Down Spring or Clip Retaining**

4 Cyl : CJ, 1980-86 use J3143612  
4 Cyl : Wr, 1987-89 use J3143612

6 Cyl : CJ, 1979-86 use J3143612  
6 Cyl : Wr, 1987-89 use J3143612

8 Cyl : CJ, 1979-81 use J3143612

NOTE:

1. WITH DANA MODEL 44 AXLE USE J3210994.

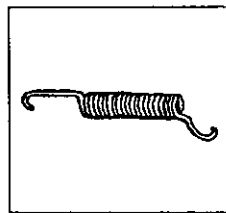

8.008

**SPRING, Brake Shoe Automatic Adjusting Lever**

4 Cyl : CJ, 1980-86 use J3201937  
4 Cyl : Wr, 1987-89 use J3201937

6 Cyl : CJ, 1979-86 use J3201937  
6 Cyl : Wr, 1987-89 use J3201937

8 Cyl : CJ, 1979-81 use J3201937

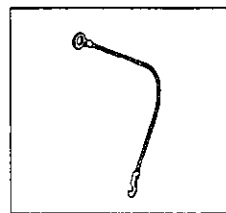

8.010

**CABLE, Brake Shoe Automatic Adjusting Link**

4 Cyl : CJ, 1980-86 use J3201027  
4 Cyl : Wr, 1987-89 use J3201027

6 Cyl : CJ, 1979-86 use J3201027  
6 Cyl : Wr, 1987-89 use J3201027

8 Cyl : CJ, 1979-81 use J3201027

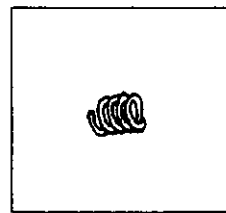

8.008

**SPRING, Shoe Hold Down Rear**

4 Cyl : CJ, 1980-86 use J3205979  
4 Cyl : Wr, 1987-89 use J3205979

6 Cyl : CJ, 1979-86 use J3205979  
6 Cyl : Wr, 1987-89 use J3205979

8 Cyl : CJ, 1979-81 use J3205979

NOTE:

1. WITH DANA MODEL 44 AXLE USE J3201956.

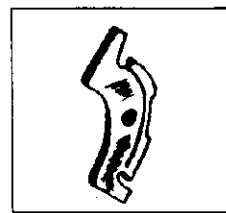

8.011

**GUIDE, Brake Shoe Automatic Adjusting Cable**

4 Cyl : CJ, 1980-82 use J3201947  
4 Cyl : Wr, 1987-89 use J3201947

6 Cyl : CJ, 1979-80 use J3201947  
6 Cyl : Wr, 1987-89 use J3201947

8 Cyl : CJ, 1979-81 use J3201947



**8.012**

**LEVER, Brake Shoe Automatic Adjusting - Left**

4 Cyl : CJ, 1980-86 use J3201029  
4 Cyl : Wr, 1987-89 use J3201029

6 Cyl : CJ, 1979-86 use J3201029  
6 Cyl : Wr, 1987-89 use J3201029

8 Cyl : CJ, 1979-81 use J3201029

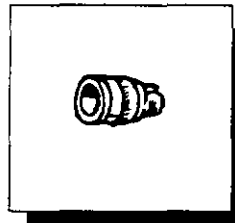

**8.014**

**SOCKET, Brake Shoe Adjusting Screw**

4 Cyl : CJ, 1980-86 use J3207638

6 Cyl : CJ, 1979-86 use J3207638

8 Cyl : CJ, 1979-81 use J3207638



**8.012**

**LEVER, Brake Shoe Automatic Adjusting - Right**

4 Cyl : CJ, 1980-86 use J3201030  
4 Cyl : Wr, 1987-89 use J3201030

6 Cyl : CJ, 1979-86 use J3201030  
6 Cyl : Wr, 1987-89 use J3201030

8 Cyl : CJ, 1979-81 use J3201030

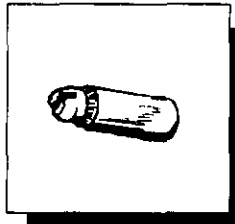

**8.014**

**NUT, Brake Shoe Adjusting Screw Left**

4 Cyl : CJ, 1980-86 use J3201917

6 Cyl : CJ, 1979-86 use J3201917

8 Cyl : CJ, 1979-81 use J3201917

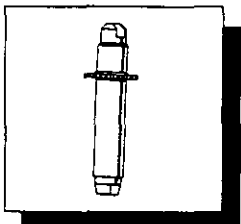

**8.014**

**SCREW, Brake Shoe Adjusting - Left**

4 Cyl : CJ, 1980-86 use J3201022  
4 Cyl : Wr, 1987-89 use 52001215

6 Cyl : CJ, 1979-86 use J3201022  
6 Cyl : Wr, 1987-89 use 52001215

8 Cyl : CJ, 1979-81 use J3201022

**NOTE: 1. COMPLETE ASSEMBLY INCLUDING SCREW, SOCKET & NUT. WITH MODEL 44 AXLE USE 83504309.**

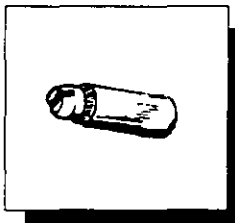

**8.014**

**NUT, Brake Shoe Adjusting Screw Right**

4 Cyl : CJ, 1980-86 use J3201918

6 Cyl : CJ, 1979-86 use J3201918

8 Cyl : CJ, 1979-81 use J3201918

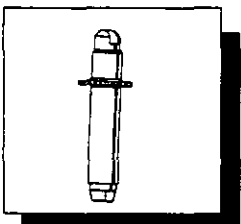

**8.014**

**SCREW, Brake Shoe Adjusting -Right**

4 Cyl : CJ, 1980-86 use J3201023  
4 Cyl : Wr, 1987-89 use 52001216

6 Cyl : CJ, 1979-86 use J3201023  
6 Cyl : Wr, 1987-89 use 52001216

8 Cyl : CJ, 1979-81 use J3201023

**NOTE: 1. COMPLETE ASSEMBLY INCLUDING SCREW, SOCKET & NUT. WITH MODEL 44 AXLE USE 83504308.**

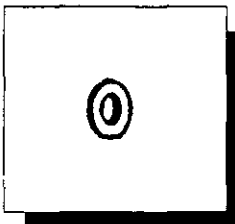

**8.014**

**WASHER, Brake Shoe Adjusting Screw**

4 Cyl : CJ, 1980-86 use J0998354

6 Cyl : CJ, 1979-86 use J0998354

8 Cyl : CJ, 1979-81 use J0998354





**8.022**

**PLATE, Brake Shoe Anchor Pin Guide**

4 Cyl : CJ, 1980-86 use J3201032  
 4 Cyl : Wr, 1987-89 use J3201032  
 6 Cyl : CJ, 1979-86 use J3201032  
 6 Cyl : Wr, 1987-89 use J3201032  
 8 Cyl : CJ, 1979-81 use J3201032

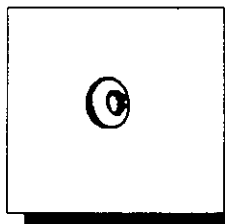

**8.024**

**WASHER, Brake Shoe Parking Lever Strut**

4 Cyl : CJ, 1980-86 use J3108203  
 4 Cyl : Wr, 1987-89 use J3108203  
 6 Cyl : CJ, 1979-86 use J3108203  
 6 Cyl : Wr, 1987-89 use J3108203  
 8 Cyl : CJ, 1979-81 use J3108203

**NOTE:**

1. WITH DANA MODEL 44 AXLE USE 83502900.

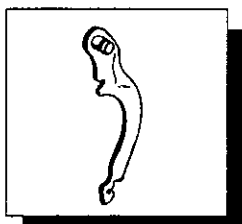

**8.024**

**LEVER, Brake Shoe Parking - Left**

4 Cyl : CJ, 1980-86 use J3201033  
 4 Cyl : Wr, 1987-89 use J3201033  
 6 Cyl : CJ, 1979-86 use J3201033  
 6 Cyl : Wr, 1987-89 use J3201033  
 8 Cyl : CJ, 1979-81 use J3201033

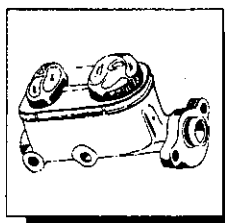

**8.035**

**CYLINDER ASSY, Brake Master (without Power Brakes) 1**

4 Cyl : CJ, 1980-81 use J5359552  
 4 Cyl : CJ, 1982-83 use J8134270  
 4 Cyl : CJ, 1984-86 use J5364779  
 6 Cyl : CJ, 1979-81 use J5359552  
 6 Cyl : CJ, 1982-83 use J8134270  
 6 Cyl : CJ, 1984-86 use J5364779  
 8 Cyl : CJ, 1979-81 use J5359552

**NOTE:**

1. FOR MASTER CYLINDER W/ POWER BRAKES REFER TO GROUP #8.510.

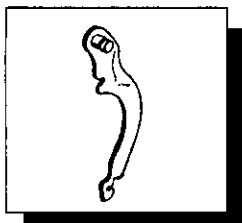

**8.024**

**LEVER, Brake Shoe Parking - Right**

4 Cyl : CJ, 1980-86 use J3201034  
 4 Cyl : Wr, 1987-89 use J3201034  
 6 Cyl : CJ, 1979-86 use J3201034  
 6 Cyl : Wr, 1987-89 use J3201034  
 8 Cyl : CJ, 1979-81 use J3201034

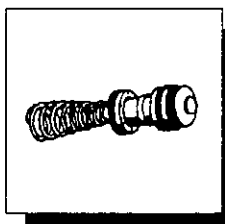

**8.048**

**REPAIR KIT, Brake Master Cylinder (Without Power Brakes)**

4 Cyl : CJ, 1980-81 use J8132592  
 4 Cyl : CJ, 1982 use J8134266  
 4 Cyl : CJ, 1983-86 use 83500896  
 6 Cyl : CJ, 1979 use J8130379  
 6 Cyl : CJ, 1980-81 use J8132592  
 6 Cyl : CJ, 1982 use J8134266  
 6 Cyl : CJ, 1983-86 use 83500896  
 8 Cyl : CJ, 1979 use J8130379  
 8 Cyl : CJ, 1980-81 use J8132592



**8.024**

**RETAINER, Brake Shoe Parking Brake Lever Strut**

4 Cyl : CJ, 1980-86 use J3108202  
 4 Cyl : Wr, 1987-89 use J3108202  
 6 Cyl : CJ, 1979-86 use J3108202  
 6 Cyl : Wr, 1987-89 use J3108202  
 8 Cyl : CJ, 1979-81 use J3108202

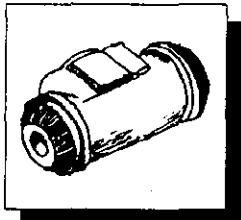

**8.068**

**CYLINDER ASSY, Brake Wheel**  
Rear - Left

4 Cyl : CJ, 1980-86 use J3225197  
4 Cyl : Wr, 1987-89 use 52000849  
  
6 Cyl : CJ, 1979-86 use J3225197  
6 Cyl : Wr, 1987-89 use 52000849  
  
8 Cyl : CJ, 1979-81 use J3225197

NOTE: 1. 1986, FOR 10 BOLT REAR AXLE COVER USE 52000849.

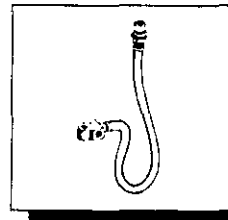

**8.116**

**HOSE, Brake Tube**  
(Rear Axle Tee & Flex Lining)

4 Cyl : CJ, 1980 use J5359570  
4 Cyl : CJ, 1981-86 use J5362842  
4 Cyl : Wr, 1987-89 use 52001917  
  
6 Cyl : CJ, 1979-80 use J5359570  
6 Cyl : CJ, 1981-86 use J5362842  
6 Cyl : Wr, 1987-89 use 52001917  
  
8 Cyl : CJ, 1979-80 use J5359570  
8 Cyl : CJ, 1981 use J5362842

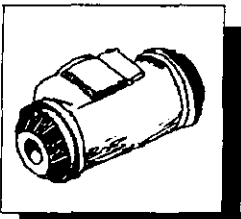

**8.068**

**CYLINDER ASSY, Brake Wheel**  
Rear - Right

4 Cyl : CJ, 1980-86 use J3225196  
4 Cyl : Wr, 1987-89 use 52000848  
  
6 Cyl : CJ, 1979-86 use J3225196  
6 Cyl : Wr, 1987-89 use 52000848  
  
8 Cyl : CJ, 1979-81 use J3225196

NOTE: 1. 1986, FOR 10 BOLT REAR AXLE COVER USE 52000848.

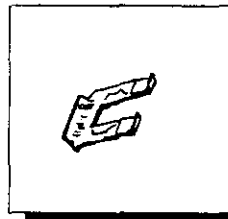

**8.116**

**CLIP, Brake Tube Fastening**

4 Cyl : CJ, 1980-86 use J0637427  
4 Cyl : Wr, 1987-89 use J0047774  
  
6 Cyl : CJ, 1979-86 use J0637427  
6 Cyl : CJ, 1987-89 use J0047774  
  
8 Cyl : CJ, 1979-81 use J0637427

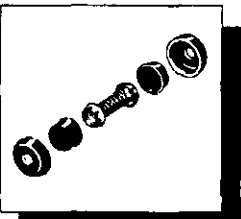

**8.080**

**REPAIR KIT, Rear Brake Wheel**  
Cylinder

4 Cyl : CJ, 1980 use J8127591  
4 Cyl : CJ, 1981-86 use J8125878  
4 Cyl : Wr, 1987-89 use 83500987  
  
6 Cyl : CJ, 1979-80 use J8127591  
6 Cyl : CJ, 1981-86 use J8125878  
6 Cyl : Wr, 1987-89 use 83500987  
  
8 Cyl : CJ, 1979-80 use J8127591  
8 Cyl : CJ, 1981 use J8125878

NOTE: 1. 1986, FOR 10 BOLT REAR AXLE COVER USE 83500987.  
2. WITH 7/8" I.D. USE J8125878.

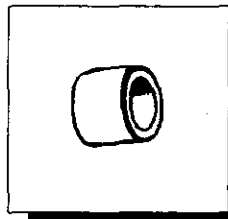

**8.140**

**BEARING, Brake Pedal**

4 Cyl : CJ, 1980-86 use J0946177  
4 Cyl : Wr, 1987-89 use J0946177  
  
6 Cyl : CJ, 1979-86 use J0946177  
6 Cyl : Wr, 1987-89 use J0946177  
  
8 Cyl : CJ, 1979-81 use J0946177

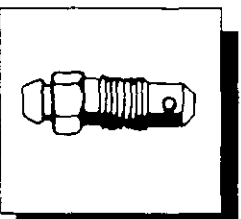

**8.088**

**SCREW, Brake Wheel Cylinder**  
Bleeder - Rear

4 Cyl : CJ, 1980-86 use J3203313  
4 Cyl : Wr, 1987-89 use J3203313  
  
6 Cyl : CJ, 1979-86 use J3203313  
6 Cyl : Wr, 1987-89 use J3203313  
  
8 Cyl : CJ, 1979-81 use J3203313

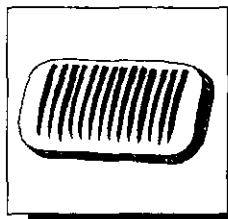

**8.148**

**COVER, Brake Pedal Pad Rubber**  
With Auto Transmission

4 Cyl : CJ, 1980-81 use J5351261  
4 Cyl : CJ, 1982-86 use J5363521  
4 Cyl : Wr, 1987-89 use 52002749  
  
6 Cyl : CJ, 1979-81 use J5351261  
6 Cyl : CJ, 1982-86 use J5363521  
6 Cyl : Wr, 1987-89 use 52002749  
  
8 Cyl : CJ, 1979-81 use J5351261

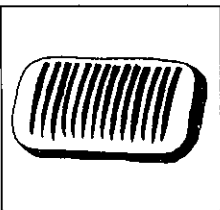

**8.148**

**COVER, Brake Pedal Pad Rubber With Manual Transmission**

4 Cyl : CJ, 1980-81 use J0948758  
 4 Cyl : CJ, 1982-86 use J5363508  
 4 Cyl : Wr, 1987-89 use 52002750

6 Cyl : CJ, 1979-81 use J0948758  
 6 Cyl : CJ, 1982-86 use J5363508  
 6 Cyl : Wr, 1987-89 use 52002750

8 Cyl : CJ, 1979-81 use J0948758

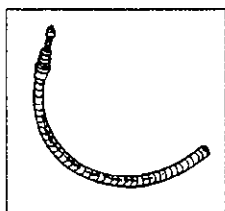

**8.192**

**CABLE, Foot Operated Parking Brake Lever To Equalizer**

4 Cyl : CJ, 1980-86 use J5353238 1  
 4 Cyl : Wr, 1987-89 use 52003181 2

6 Cyl : CJ, 1979-86 use J5353238 1  
 6 Cyl : Wr, 1987-89 use 52003181 2

8 Cyl : CJ, 1979-81 use J5353238 1

**NOTE:** 1. 1979-85, THIS IS FOR CJ-7. FOR CJ-5 USE J5355287. FOR CJ-8 USE J5355286.  
 2. VEHICLES W/ 103" WHEELBASE USE 52002815.

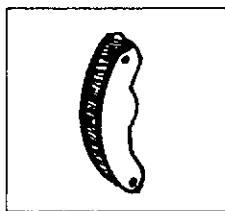

**8.214**

**EQUALIZER, Parking Brake Cable**

4 Cyl : CJ, 1980-86 use J3222572  
 4 Cyl : Wr, 1987-89 use 52001154

6 Cyl : CJ, 1979-86 use J3222572  
 6 Cyl : Wr, 1987-89 use 52001154

8 Cyl : CJ, 1979-81 use J3222572

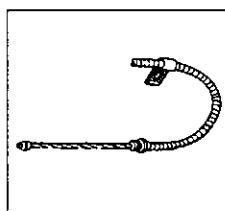

**8.220**

**CABLE, Equalizer To Rear Wheels - Left**

4 Cyl : CJ, 1980 use J3233903  
 4 Cyl : CJ, 1981-86 use J3242203 1  
 4 Cyl : Wr, 1987-89 use 52003183

6 Cyl : CJ, 1979-80 use J3233903  
 6 Cyl : CJ, 1981-86 use J3242203 1  
 6 Cyl : Wr, 1987-89 use 52003183

8 Cyl : CJ, 1979-80 use J3233903  
 8 Cyl : CJ, 1981 use J3242203 1

**NOTE:** 1. 1981-83, FOR CJ-5 USE J3233903.

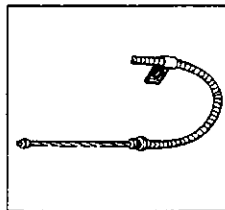

**8.220**

**CABLE, Equalizer To Rear Wheels - Right**

4 Cyl : CJ, 1980 use J3233904  
 4 Cyl : CJ, 1981-86 use J3239949  
 4 Cyl : Wr, 1987-89 use 52003182

6 Cyl : CJ, 1979-80 use J3233904  
 6 Cyl : CJ, 1981-86 use J3239949  
 6 Cyl : Wr, 1987-89 use 52003182

8 Cyl : CJ, 1979-80 use J3233904  
 8 Cyl : CJ, 1981 use J3239949

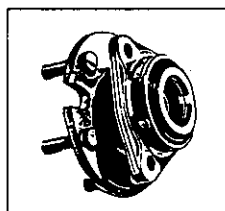

**8.243**

**HUB ASSY, Front Brake (With Bolts)**

4 Cyl : Wr, 1987-89 use 53000228

6 Cyl : Wr, 1987-89 use 53000228

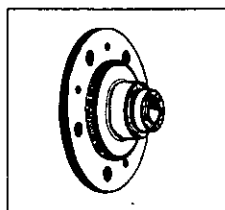

**8.243**

**HUB ASSY, Rear Brake (With Bolts)**

4 Cyl : CJ, 1980-86 use J8133730

6 Cyl : CJ, 1979-86 use J8133730

8 Cyl : CJ, 1979-81 use J8133730

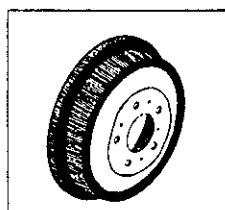

**8.245**

**DRUM, Rear Brake (Without Hub)**

4 Cyl : CJ, 1980-86 use J5359028  
 4 Cyl : Wr, 1987-89 use 52001151

6 Cyl : CJ, 1979-86 use J5359028  
 6 Cyl : Wr, 1987-89 use 52001151

8 Cyl : CJ, 1979-81 use J5359028

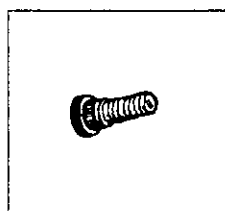

**8.245**

**BOLT, Rear Axle Wheel Stud**

4 Cyl : CJ, 1980-86 use J5355719  
 4 Cyl : Wr, 1987-89 use 83503053

6 Cyl : CJ, 1979-86 use J5355719  
 6 Cyl : Wr, 1987-89 use 83503053

8 Cyl : CJ, 1979-81 use J5355719

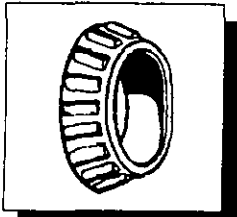

**8.292**

**BEARING, Front Wheel - Inner**

4 Cyl : CJ, 1980-86 use J5356661  
 4 Cyl : Wr, 1987-89 use 53000238

6 Cyl : CJ, 1979-86 use J5356661  
 6 Cyl : Wr, 1987-89 use 53000238

8 Cyl : CJ, 1979-81 use J5356661

NOTE: 1. BEARING ASSY HAS CUP & BEARING.

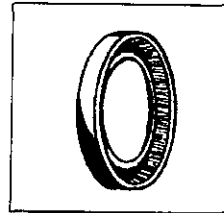

**8.296**

**RETAINER, Front Wheel Grease**

4 Cyl : CJ, 1980-83 use J5356675  
 4 Cyl : CJ, 1984-86 use J5365082  
 4 Cyl : Wr, 1987-89 use J3238137

6 Cyl : CJ, 1979-83 use J5356675  
 6 Cyl : CJ, 1984-86 use J5365082  
 6 Cyl : Wr, 1987-89 use J3238137

8 Cyl : CJ, 1979-81 use J5356675

NOTE: 1. OUTER SEAL. FOR INNER SEAL USE 53000239.

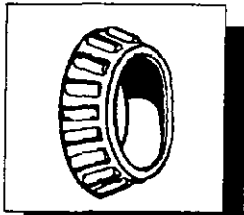

**8.292**

**BEARING, Front Wheel - Outer**

4 Cyl : CJ, 1980-86 use J3156052  
 4 Cyl : Wr, 1987-89 use 53000238

6 Cyl : CJ, 1979-86 use J3156052  
 6 Cyl : Wr, 1987-89 use 53000238

8 Cyl : CJ, 1979-81 use J3156052

NOTE: 1. BEARING ASSY HAS CUP & BEARING.

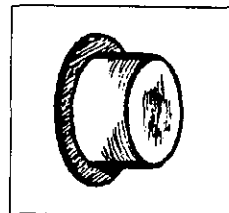

**8.296**

**CAP, Front Wheel Grease Retainer - Outer**

4 Cyl : CJ, 1980-86 use J0947085

6 Cyl : CJ, 1979-86 use J0947085

8 Cyl : CJ, 1979-81 use J0947085

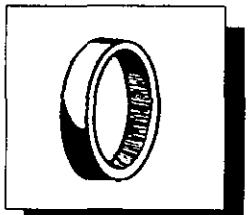

**8.294**

**CUP, Front Wheel Bearing - Inner**

4 Cyl : CJ, 1980-86 use J8127630

6 Cyl : CJ, 1979-86 use J8127630

8 Cyl : CJ, 1979-81 use J8127630

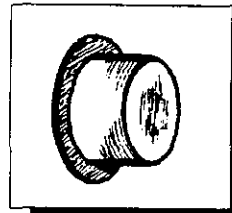

**8.296**

**CAP, Rear Wheel Grease Retainer - Outer**

4 Cyl : CJ, 1980 use J5355749

4 Cyl : CJ, 1981-86 use J5362142

6 Cyl : CJ, 1979-80 use J5355749

6 Cyl : CJ, 1981-86 use J5362142

8 Cyl : CJ, 1979-80 use J5355749

8 Cyl : CJ, 1981 use J5362142

NOTE: 1. 1981, FOR REAR HUB GREASE CAP THAT IS 2-1/2" O.D. USE J5355749.

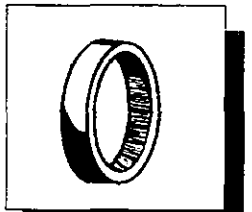

**8.294**

**CUP, Front Wheel Bearing - Outer**

4 Cyl : CJ, 1980-86 use J0925447

6 Cyl : CJ, 1979-86 use J0925447

8 Cyl : CJ, 1979-81 use J0925447

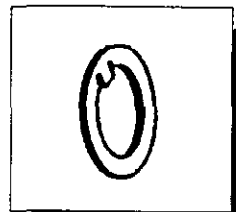

**8.296**

**WASHER, Front Wheel Bearing Lock**

4 Cyl : CJ, 1980-86 use JA000865

4 Cyl : Wr, 1987-89 use J0420096

6 Cyl : CJ, 1979-80 use JA000865

6 Cyl : Wr, 1987-89 use J0420096

8 Cyl : CJ, 1979-81 use JA000865

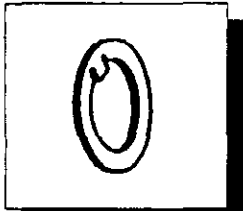

**8.296**

**WASHER, Front Wheel Bearing Nut Lock**

4 Cyl : CJ, 1980-86 use JA000867  
4 Cyl : Wr, 1987-89 use J0420097

6 Cyl : CJ, 1979-86 use JA000867  
6 Cyl : Wr, 1987-89 use J0420097

8 Cyl : CJ, 1979-81 use JA000867

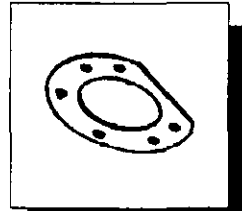

**8.303**

**RETAINER, Rear Wheel Bearing (Flanged Axle)**

4 Cyl : Wr, 1987-89 use 83503022

6 Cyl : Wr, 1987-89 use 83503022

NOTE: 1. WITH MODEL 44 AXLE USE 83504190.

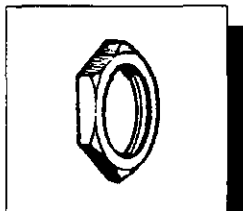

**8.296**

**NUT, Front Wheel Bearing Retaining Inner & Outer**

4 Cyl : CJ, 1980-86 use JA000866  
4 Cyl : Wr, 1987-89 use J0420095

6 Cyl : CJ, 1979-86 use JA000866  
6 Cyl : Wr, 1987-89 use J0420095

8 Cyl : CJ, 1979-81 use JA000866

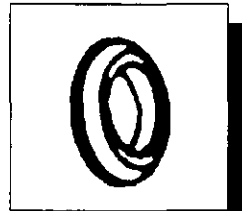

**8.303**

**RING, Rear Wheel Bearing (Flanged Axle)**

4 Cyl : Wr, 1987-89 use 83503054

6 Cyl : Wr, 1987-89 use 83503054

NOTE: 1. WITH MODEL 44 AXLE USE 83503077.

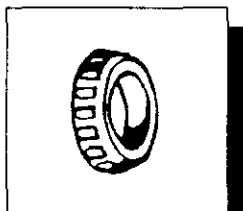

**8.300**

**BEARING, Rear Wheel**

4 Cyl : CJ, 1980-86 use J3150046  
4 Cyl : Wr, 1987-89 use 53000475

6 Cyl : CJ, 1979-86 use J3150046  
6 Cyl : Wr, 1987-89 use 53000475

8 Cyl : CJ, 1979-81 use J3150046

NOTE: 1. 1986, USED WITH 10 BOLT REAR AXLE COVER USE J3230115.  
2. WITH MODEL 44 AXLE USE 83503064.  
BEARING ASSY INCLUDES CUP.

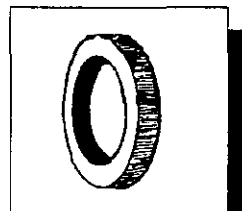

**8.312**

**SEAL, Rear Wheel Oil**

4 Cyl : CJ, 1983-86 use J4485691

4 Cyl : Wr, 1987-89 use 53000477

6 Cyl : CJ, 1979-86 use J4485691

6 Cyl : Wr, 1987-89 use 53000477

8 Cyl : CJ, 1979-81 use J4485691

NOTE: 1. WITH MODEL 44 AXLE USE 83503063.

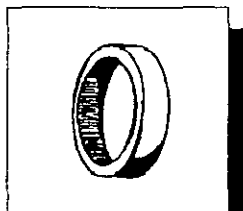

**8.300**

**CUP, Rear Wheel Bearing**

4 Cyl : CJ, 1980 use J3150045  
4 Cyl : CJ, 1981-86 use J5360955

6 Cyl : CJ, 1979-80 use J3150045  
6 Cyl : CJ, 1981-86 use J5360955

8 Cyl : CJ, 1979-80 use J3150045  
8 Cyl : CJ, 1981 use J5360955

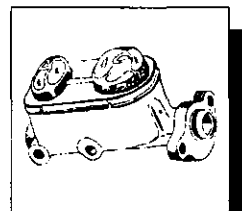

**8.510**

**CYLINDER ASSY, Power Brake Master**

4 Cyl : CJ, 1980-81 use J5358746

4 Cyl : CJ, 1982-83 use J8133921

4 Cyl : CJ, 1984-86 use 83500995

4 Cyl : Wr, 1987-89 use J3241807

6 Cyl : CJ, 1979-81 use J5358746

6 Cyl : CJ, 1982-83 use J8133921

6 Cyl : CJ, 1984-86 use 83500995

6 Cyl : Wr, 1987-89 use J3241807

8 Cyl : CJ, 1979-81 use J5358746

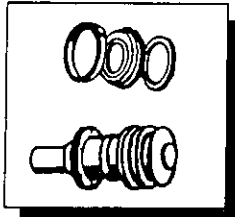

**8.512**

**REPAIR KIT, Power Brake Master Cylinder**

4 Cyl : CJ, 1980-86 use J8134277  
 4 Cyl : Wr, 1987-89 use J8133913  
  
 6 Cyl : CJ, 1979-86 use J8134277  
 6 Cyl : Wr, 1987-89 use J8133913  
  
 8 Cyl : CJ, 1979-81 use J8134277

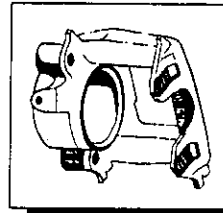

**8.810**

**CALIPER ASSY, Front Wheel Disc Brake (Without Pads) - Left**

4 Cyl : CJ, 1980-81 use J8131648  
 4 Cyl : CJ, 1982-86 use J8133847  
 4 Cyl : Wr, 1987-89 use J8133847  
  
 6 Cyl : CJ, 1979-81 use J8131648  
 6 Cyl : CJ, 1982-86 use J8133847  
 6 Cyl : Wr, 1987-89 use J8133847  
  
 8 Cyl : CJ, 1979-81 use J8131648

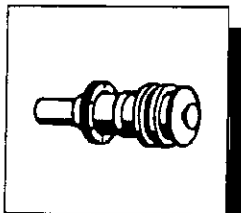

**8.515**

**PISTON, Power Brake Master Cylinder Secondary**

4 Cyl : CJ, 1980-86 use J8130063  
 4 Cyl : Wr, 1987-89 use J8133915  
  
 6 Cyl : CJ, 1979-86 use J8130063  
 6 Cyl : Wr, 1987-89 use J8133915  
  
 8 Cyl : CJ, 1979-81 use J8130063

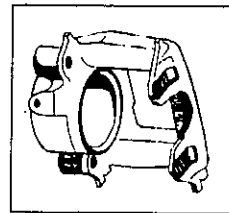

**8.810**

**CALIPER ASSY, Front Wheel Disc Brake (Without Pads) - Right**

4 Cyl : CJ, 1980-81 use J8131649  
 4 Cyl : CJ, 1982-86 use J8133846  
 4 Cyl : Wr, 1987-89 use J8133846  
  
 6 Cyl : CJ, 1979-81 use J8131649  
 6 Cyl : CJ, 1982-86 use J8133846  
 6 Cyl : Wr, 1987-89 use J8133846  
  
 8 Cyl : CJ, 1979-81 use J8131649

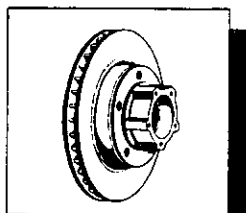

**8.805**

**DISC ASSY, Front Wheel Disc Brake (With Hubs)**

4 Cyl : CJ, 1980-81 use J5358568 2  
 4 Cyl : CJ, 1982-86 use J5363421  
 4 Cyl : Wr, 1987-89 use J3251156 1  
  
 6 Cyl : CJ, 1979-81 use J5358568 2  
 6 Cyl : CJ, 1982-86 use J5363421  
 6 Cyl : Wr, 1987-89 use J3251156 1  
  
 8 Cyl : CJ, 1979-81 use J5358568

NOTE: 1. DOES NOT INCLUDE HUB, SEE 8.243.  
 2. WITH 6 BOLT OUTER FLANGE MOUNTING.

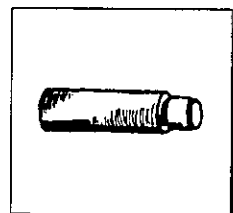

**8.810**

**BOLT, Housing Retainer - Disc Caliper Brake**

4 Cyl : CJ, 1982-86 use J3239866  
 4 Cyl : Wr, 1987-89 use 83504655  
  
 6 Cyl : CJ, 1982-86 use J3239866  
 6 Cyl : Wr, 1987-89 use 83504655

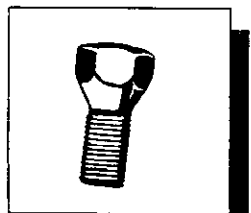

**8.805**

**STUD, Front Wheel Disc Brake Assy To Wheel**

4 Cyl : CJ, 1980-86 use J5357196  
 4 Cyl : Wr, 1987-89 use J3238138  
  
 6 Cyl : CJ, 1979-86 use J5357196  
 6 Cyl : Wr, 1987-89 use J3238138  
  
 8 Cyl : CJ, 1979-81 use J5357196

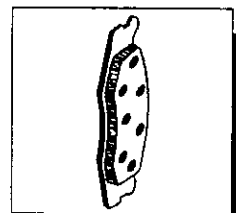

**8.815**

**SHOE SET, Front Wheel Disc Brake**

4 Cyl : CJ, 1980-81 use J8131785  
 4 Cyl : CJ, 1982-86 use J8133853  
 4 Cyl : Wr, 1987-89 use 83501167  
  
 6 Cyl : CJ, 1979-81 use J8131785  
 6 Cyl : CJ, 1982-86 use J8133853  
 6 Cyl : Wr, 1987-89 use 83501167  
  
 8 Cyl : CJ, 1979-81 use J8131785

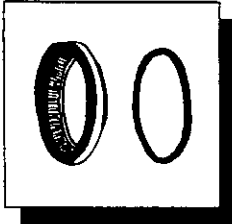

8.820

**REPAIR KIT, Disc Brake Piston Housing (With Boot & Seal)**

4 Cyl : CJ, 1980-81 use J8127583  
 4 Cyl : CJ, 1982-86 use J8133852  
 4 Cyl : Wr, 1987-89 use J8133852

6 Cyl : CJ, 1979-81 use J8127583  
 6 Cyl : CJ, 1982-86 use J8133852  
 6 Cyl : Wr, 1987-89 use J8133852

8 Cyl : CJ, 1979-80 use J8127583

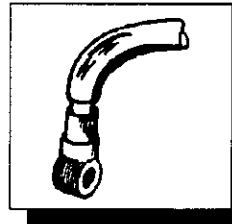

8.855

**HOSE, Front Wheel Disc Brakes - Right**

4 Cyl : CJ, 1980-81 use J5359037  
 4 Cyl : CJ, 1982-86 use J5363756  
 4 Cyl : Wr, 1987-89 use 52002848

6 Cyl : CJ, 1979-81 use J5359037  
 6 Cyl : CJ, 1982-86 use J5363756  
 6 Cyl : Wr, 1987-89 use 52002848

8 Cyl : CJ, 1979-81 use J5359037

NOTE: 1. 1982-83, FOR CJ-5 USE J5363917

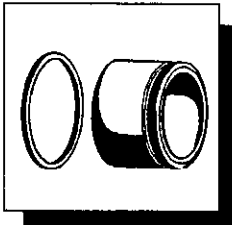

8.820

**REPAIR KIT, Disc Brake Piston Housing (Includes Piston)**

4 Cyl : CJ, 1980-81 use J8127582  
 4 Cyl : CJ, 1982-86 use J8133845  
 4 Cyl : Wr, 1987-89 use J8133845

6 Cyl : CJ, 1979-81 use J8127582  
 6 Cyl : CJ, 1982-86 use J8133845  
 6 Cyl : Wr, 1987-89 use J8133845

8 Cyl : CJ, 1979-81 use J8127582

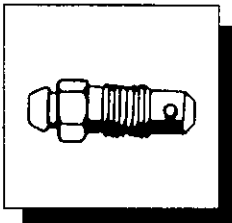

8.830

**SCREW, Brake Wheel Cylinder Bleeder**

4 Cyl : CJ, 1980-86 use J3203313  
 4 Cyl : Wr, 1987-89 use J3203313

6 Cyl : CJ, 1979-86 use J3203313  
 6 Cyl : Wr, 1987-89 use J3203313

8 Cyl : CJ, 1979-81 use J3203313

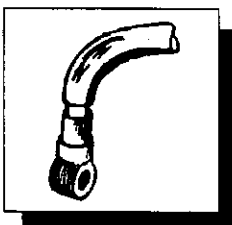

8.855

**HOSE, Front Wheel Disc Brakes - Left**

4 Cyl : CJ, 1980-81 use J5359037  
 4 Cyl : CJ, 1982-86 use J5363908  
 4 Cyl : Wr, 1987-89 use 52002849

6 Cyl : CJ, 1979-81 use J5359037  
 6 Cyl : CJ, 1982-86 use J5363908  
 6 Cyl : Wr, 1987-89 use 52002849

8 Cyl : CJ, 1979-81 use J5359037

NOTE: 1. 1982-83, FOR CJ-5 USE J5363917.

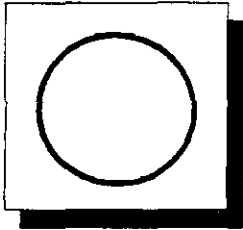

**9.007**

**GASKET, Rear Axle Housing Cover**

4 Cyl : CJ, 1980-86 use J3172122  
 4 Cyl : Wr, 1987-89 use J8993317

6 Cyl : CJ, 1979-86 use J3172122  
 6 Cyl : Wr, 1987-89 use J8993317

8 Cyl : CJ, 1979-81 use J3172122

**NOTE:** 1. J8993317 IS LIQUID GASKET IN A TUBE. FOR MODEL 44 AXLE YOU CAN USE J8122409.

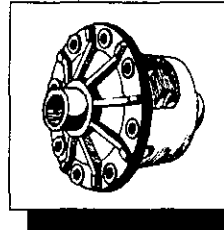

**9.021**

**CASE, Rear Axle Differential (Without Locking Differential) Standard**

4 Cyl : CJ, 1980 use J3212051  
 4 Cyl : Wr, 1987-89 use 53000561

6 Cyl : CJ, 1979-80 use J3212051  
 6 Cyl : Wr, 1987-89 use 53000561

8 Cyl : CJ, 1979-80 use J3212051

**NOTE:** 1. USED WITH DANA MODEL 35 AXLE. FOR MODEL 44 AXLE USE 83503073.

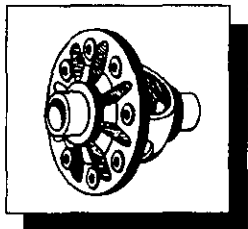

**9.021**

**CASE ASSY, Rear Axle Differential Without Locking Differential-Standard**

4 Cyl : CJ, 1980 use J3191373  
 4 Cyl : CJ, 1981-86 use J3228921

6 Cyl : CJ, 1979-80 use J3191373  
 6 Cyl : CJ, 1981-86 use J3228921

8 Cyl : CJ, 1979-80 use J3191373  
 8 Cyl : CJ, 1981 use J3228921

**NOTE:** 1. 1986, FOR 2:72, 3:31, 3:54 RATIOS USE 83503073. FOR 4:09, 4:56 USE 83503067.

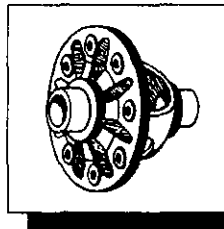

**9.024**

**CASE, Rear Axle Differential-Model 20 (W/ Locking Differential) Case Only**

4 Cyl : CJ, 1980 use J8120280  
 4 Cyl : Wr, 1987 use 53000986  
 4 Cyl : Wr, 1988-89 use 83505021

6 Cyl : CJ, 1979-80 use J8120280  
 6 Cyl : Wr, 1987 use 53000986  
 6 Cyl : Wr, 1988-89 use 83505021

8 Cyl : CJ, 1979-80 use J8120280

**NOTE:** 1. WITH MODEL 35 AXLE. FOR MODEL 44 AXLE USE J8129218.

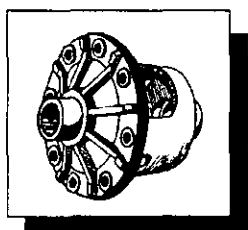

**9.021**

**CASE ASSY, Rear Axle Differential (Model 20 - Trac-Lok)**

4 Cyl : CJ, 1980 use J8120235  
 4 Cyl : CJ, 1981-86 use J3212192

6 Cyl : CJ, 1979-80 use J8120235  
 6 Cyl : CJ, 1981-86 use J3212192

8 Cyl : CJ, 1979-80 use J8120235  
 8 Cyl : CJ, 1981 use J3212192

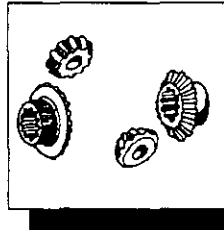

**9.027**

**GEAR SET, Rear Axle Differential Side (W/O Locking Diff.) Standard**

4 Cyl : CJ, 1980-86 use J8127092<sup>1</sup>  
 4 Cyl : Wr, 1987-89 use 83503002<sup>2</sup>

6 Cyl : CJ, 1979-86 use J8127092<sup>1</sup>  
 6 Cyl : Wr, 1987-89 use 83503002<sup>2</sup>

8 Cyl : CJ, 1979-81 use J8127092

**NOTE:** 1. ON 10 BOLT REAR AXLE COVER USE 83503068.  
 2. WITH MODEL 44 AXLE USE 83503068.



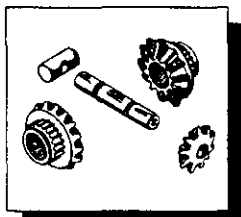

**9.027**

**GEAR SET**, Rear Axle Differential Side (W/ Locking Diff.) Trac-Lok

4 Cyl : CJ, 1980-86 use J8120326 <sup>1</sup>  
 4 Cyl : Wr, 1987 use 83500262 <sup>2</sup>  
 4 Cyl : Wr, 1988-89 use 83505022 <sup>2</sup>

6 Cyl : CJ, 1979-86 use J8120326 <sup>1</sup>  
 6 Cyl : Wr, 1987 use 83500262 <sup>2</sup>  
 6 Cyl : Wr, 1988-89 use 83505022 <sup>2</sup>

8 Cyl : CJ, 1979-80 use J8120326

**NOTE:** 1. 1986, ON 10 BOLT REAR AXLE COVER USE J8129220.

2. FOR DANA MODEL 44 AXLE: IF CROSS SHAFT SECURED BY 2 RINGS USE J8129220. IF CROSS SHAFT SECURED BY ROLL PIN USE 83505432.

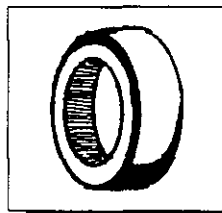

**9.041**

**BEARING**, Rear Axle Differential Side Cup

4 Cyl : CJ, 1980-86 use J3172566 <sup>1</sup>  
 4 Cyl : Wr, 1987-89 use J3171166 <sup>2</sup>

6 Cyl : CJ, 1979-86 use J3172566 <sup>1</sup>  
 6 Cyl : Wr, 1987-89 use J3171166 <sup>2</sup>

8 Cyl : CJ, 1979-81 use J3172566

**NOTE:** 1. 1986, ON 10 BOLT REAR AXLE COVER USE J0052980.

2. WITH DANA AXLE MODEL 44 USE J0052980.

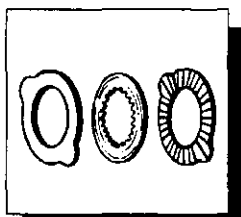

**9.035**

**DISC KIT**, Rear Axle Differential Clutch Friction (W/ Locks) Trac-Lok

4 Cyl : CJ, 1980-86 use J8120325 <sup>1</sup>  
 4 Cyl : Wr, 1987-89 use 83500263 <sup>2</sup>

6 Cyl : CJ, 1979-86 use J8120325 <sup>1</sup>  
 6 Cyl : Wr, 1987-89 use 83500263 <sup>2</sup>

8 Cyl : CJ, 1979-81 use J8120325

**NOTE:** 1. 1986, ON 10 BOLT REAR AXLE COVER USE J0994345.

2. WITH DANA AXLE MODEL 44 USE J0994345.

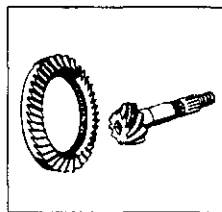

**9.050**

**GEAR SET**, Rear Axle Ring & Pinion (W/O Brgs, Seals, Gasket & Shims) **3:08 Ratio**

4 Cyl : CJ, 1979-80 use J8130388 <sup>3</sup>  
 4 Cyl : Wr, 1987-89 use 83503021 <sup>1,2</sup>

6 Cyl : CJ, 1979-80 use J8130388 <sup>3</sup>  
 6 Cyl : CJ, 1987-89 use 83503021 <sup>2</sup>

8 Cyl : CJ, 1979-80 use J8130388 <sup>3</sup>

**NOTE:** 1. BOLT HEIGHT IN BOLT KIT IS .66". FOR BOLT HEIGHT .81" USE GEAR SET 83504934.

2. FOR DANA 44 W/ 3:07 RATIO USE 83504197.

3. 3:07 RATIO.

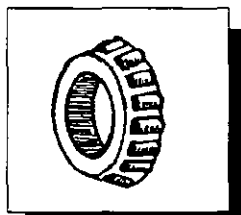

**9.041**

**BEARING**, Rear Axle Differential Side Bearing Cone

4 Cyl : CJ, 1980-86 use J3172565 <sup>1</sup>  
 4 Cyl : Wr, 1987-89 use J3156052 <sup>2</sup>

6 Cyl : CJ, 1979-86 use J3172565 <sup>1</sup>  
 6 Cyl : Wr, 1987-89 use J3156052 <sup>2</sup>

8 Cyl : CJ, 1979-81 use J3172565

**NOTE:** 1. 1986, ON 10 BOLT REAR AXLE COVER USE J0052979.

2. WITH DANA AXLE MODEL 44 USE J0052979.

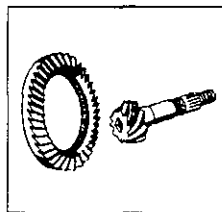

**9.050**

**GEAR SET**, Rear Axle Ring & Pinion (W/O Brgs, Seals, Gasket & Shims) **3:73 Ratio**

4 Cyl : CJ, 1981 use J8133179

6 Cyl : CJ, 1981 use J8133179

8 Cyl : CJ, 1981 use J8133179

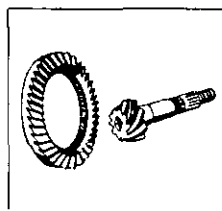

**9.050**

**GEAR SET**, Rear Axle Ring & Pinion (W/O Brgs, Seals, Gasket & Shims) **3:54 Ratio**

4 Cyl : CJ, 1980-86 use J4486825  
 4 Cyl : Wr, 1987-89 use 83503197 <sup>1,2</sup>

6 Cyl : CJ, 1979-86 use J4486825  
 6 Cyl : Wr, 1987-89 use 83503197 <sup>1,2</sup>

8 Cyl : CJ, 1979-81 use J4486825

**NOTE:** 1. THIS IS A 3:55 RATIO.

2. FOR DANA 44 W/ 3:54 RATIO USE 83503437.

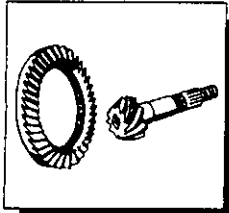

**9.050**

**GEAR SET**, Rear Axle Ring & Pinion  
(W/O Brgs, Seals, Gasket & Shims)  
**4:10 Ratio**

4 Cyl : CJ, 1980-86 use J8127072  
4 Cyl : Wr, 1987-89 use 83502486

6 Cyl : CJ, 1979-86 use J8127072  
6 Cyl : Wr, 1987-89 use 83502486

8 Cyl : CJ, 1979-81 use J8127072

**NOTE:** 1. THIS IS A 4:11 RATIO.

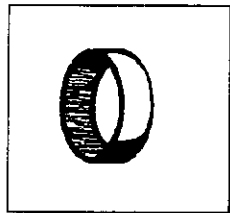

**9.055**

**CUP**, Rear Axle Pinion Bearing - Inner

4 Cyl : CJ, 1980-86 use J3172564  
4 Cyl : Wr, 1987-89 use J3156065

6 Cyl : CJ, 1979-86 use J3172564  
6 Cyl : Wr, 1987-89 use J3156065

8 Cyl : CJ, 1979-81 use J3172564

**NOTE:** 1. 1986, ON 10 BOLT REAR AXLE COVER USE J0052877.  
2. WITH DANA 44 USE J0052877.

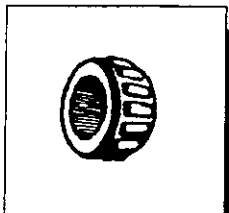

**9.052**

**BEARING**, Rear Axle Pinion  
Outer Cone

4 Cyl : CJ, 1980-86 use J3172135  
4 Cyl : Wr, 1987-89 use J3156063

6 Cyl : CJ, 1979-86 use J3172135  
6 Cyl : Wr, 1987-89 use J3156063

8 Cyl : CJ, 1979-81 use J3172135

**NOTE:** 1. 1986, ON 10 BOLT REAR AXLE COVER USE J0052878.  
2. WITH DANA 44 USE J0052878.

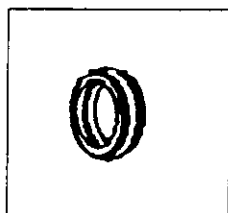

**9.056**

**SPACER**, Rear Axle Pinion  
(Crush Sleeve)

4 Cyl : CJ, 1980-86 use J3185971  
4 Cyl : Wr, 1987-89 use J3175779

6 Cyl : CJ, 1979-86 use J3185971  
6 Cyl : Wr, 1987-89 use J3175779

8 Cyl : CJ, 1979-81 use J3185971

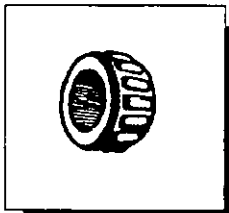

**9.052**

**BEARING**, Rear Axle Pinion  
Inner Cone

4 Cyl : CJ, 1980-86 use J3172563  
4 Cyl : Wr, 1987-89 use J3170947

6 Cyl : CJ, 1979-86 use J3172563  
6 Cyl : Wr, 1987-89 use J3170947

8 Cyl : CJ, 1979-81 use J3172563

**NOTE:** 1. 1986, ON 10 BOLT REAR AXLE COVER USE J0807266.  
2. WITH DANA 44 USE J0807266.

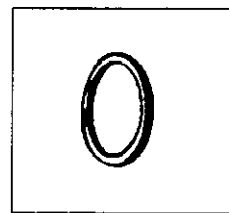

**9.057**

**SHIM SET**, Rear Axle Drive Pinion  
Adjusting

4 Cyl : CJ, 1980-86 use 3205533K  
4 Cyl : Wr, 1987-89 use 83503003

6 Cyl : CJ, 1979-86 use 3205533K  
6 Cyl : Wr, 1987-89 use 83503003

8 Cyl : CJ, 1979-81 use 3205533K

**NOTE:** 1. 1986, ON 10 BOLT REAR AXLE COVER USE J8129221.

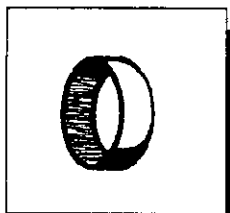

**9.055**

**CUP**, Rear Axle Pinion Bearing - Outer

4 Cyl : CJ, 1980-86 use J3172134  
4 Cyl : Wr, 1987-89 use J3156062

6 Cyl : CJ, 1979-86 use J3172134  
6 Cyl : Wr, 1987-89 use J3156062

8 Cyl : CJ, 1979-81 use J3172134

**NOTE:** 1. 1986, ON 10 BOLT REAR AXLE COVER USE J0052879.  
2. WITH DANA 44 USE J0052879.

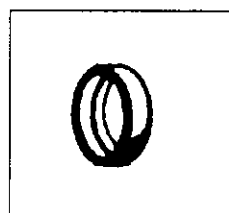

**9.064**

**OIL SEAL**, Rear Axle Pinion Bearing  
(With Pinion Nut)

4 Cyl : CJ, 1980-86 use J3208474  
4 Cyl : Wr, 1987-89 use 53002642

6 Cyl : CJ, 1979-86 use J3208474  
6 Cyl : Wr, 1987-89 use 53002642

8 Cyl : CJ, 1979-81 use J3208474

**NOTE:** 1. 1986, ON 10 BOLT REAR AXLE COVER USE J0998092.  
2. WITH DANA AXLE MODEL 44 USE 83503390 SEAL AND J0801367 NUT.

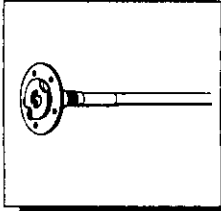

**9.068**

**SHAFT, Rear Axle  
Left**

4 Cyl : CJ, 1980-83 use J8127070 <sup>1</sup>  
 4 Cyl : CJ, 1984-86 use J8133885 <sup>2</sup>  
 4 Cyl : Wr, 1987-89 use 83502883 <sup>4</sup>

6 Cyl : CJ, 1979-83 use J8127070 <sup>1,3</sup>  
 6 Cyl : CJ, 1984-86 use J8133885 <sup>2</sup>  
 6 Cyl : Wr, 1987-89 use 83502883 <sup>4</sup>

8 Cyl : CJ, 1979-81 use J8127070

**NOTE:**

1. 1982-83, FOR CJ-7,8 USE J8133885.
2. 1986, ON 10 BOLT REAR AXLE COVER USE 83503075.
3. 1979, WITH QUADRA-TRAC USE J8127079.
4. FOR DANA AXLE MODEL 44 USE 83504961.

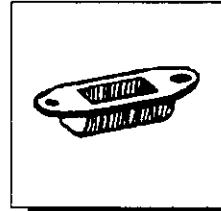

**9.086**

**BUMPER, Rear Axle**

4 Cyl : CJ, 1980-82 use J5355483  
 4 Cyl : Wr, 1987-89 use 52040007 <sup>1</sup>

6 Cyl : CJ, 1979-80 use J5355483  
 6 Cyl : Wr, 1987-89 use 52040007 <sup>1</sup>

8 Cyl : CJ, 1979-81 use J5355483

**NOTE:** 1. FOR FRONT USE 52040426.

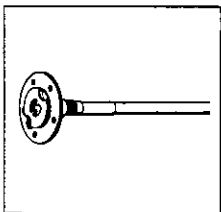

**9.068**

**SHAFT, Rear Axle  
Right**

4 Cyl : CJ, 1980-83 use J8127071 <sup>1</sup>  
 4 Cyl : CJ, 1984-86 use J8133886 <sup>2</sup>  
 4 Cyl : Wr, 1987-89 use 83502882 <sup>4</sup>

6 Cyl : CJ, 1979-83 use J8127071 <sup>1,3</sup>  
 6 Cyl : CJ, 1984-86 use J8133886 <sup>2</sup>  
 6 Cyl : Wr, 1987-89 use 83502882 <sup>4</sup>

8 Cyl : CJ, 1979-81 use J8127071 <sup>3</sup>

**NOTE:**

1. 1982-83, FOR CJ-7,8 USE J8133886.
2. 1986, ON 10 BOLT REAR AXLE COVER USE 83503074.
3. 1979, WITH QUADRA-TRAC USE J8127081.
4. FOR DANA AXLE MODEL 44 USE 83504960.

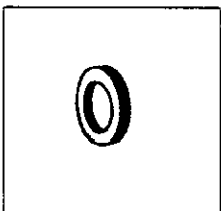

**9.072**

**OIL SEAL, Rear Axle Shaft - Inner**

4 Cyl : CJ, 1980-86 use J3170700  
 4 Cyl : Wr, 1987-89 use 53000477 <sup>1</sup>

6 Cyl : CJ, 1979-86 use J3170700  
 6 Cyl : Wr, 1987-89 use 53000477 <sup>1</sup>

8 Cyl : CJ, 1979-81 use J3170700

**NOTE:** 1. FOR DANA AXLE MODEL 44 USE 83503063.

# GROUP 9 : AXLE-PROPELLER SHAFT

CJ. WRANGLER

## PROPELLER SHAFT

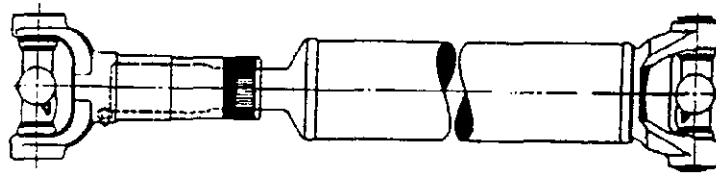

FRONT

REAR

CYL	MODEL	YEAR	TRANSMISSION //TRANSFER CASE	COLL- APSED LENGTH	PART NUMBER	CYL	MODEL	YEAR	TRANSMISSION //TRANSFER CASE	COLL- APSED LENGTH	PART NUMBER
4	CJ's	80	AUTO.	32.68	J5360985	6	CJ5	79	T150	18.00	J5356509
4	CJ's	80-81	SR4	31.75	J5360982	6	CJ5	79	T18		J5356687
4	CJ's	81	AUTO.	30.25	J5356501	6	CJ5	80	SR4	13.90	J5360983
4	CJ's	82-83	T176-177	27.25	J5362815	6	CJ6	81	SR4	12.88	J5362276
4	CJ's	83-86	T4, T5	29.50	J5360986	6	CJ7	79	T150	26.50	J5356508
4	WR	87-89	AISIN	38.00	53004369	6	CJ7	79	T18	23.87	J5356510
6	CJ's	79	AUTO.	37.00	J5359382	6	CJ7	80	T176	23.60	J5360988
6	CJ's	79	T150	26.50	J5356500	6	CJ7	80	SR4	21.10	J5360994
6	CJ's	79	T18	30.25	J5356501	6	CJ7	81	AUTO.	22.26	J5362282
6	CJ's	80	AUTO.	32.68	J5360985	6	CJ7	81-86	T176-177	22.90	J5362281
6	CJ's	80-81	SR4	31.75	J5360982	6	CJ7	81	SR4	20.80	J5360987
6	CJ's	81-86	T176-177	29.50	J5360986	6	CJ7	81-86	AUTO.	19.75	J5362280
6	CJ's	81-86	AUTO.	32.68	J5360985	6	CJ7	82-86	T4, T5	20.80	J5360987
6	CJ's	82-86	T4, T5	31.75	J5360982	6	CJ8	81	T176-177	32.88	J5362278
6	WR	87-89	AUTO.	38.00	53004369	6	CJ8	81-	SR4, T4, T5	30.60	J5362277
6	WR	87-88	PEUGEOT		53004453	6	CJ8	81-86	AUTO.	29.92	J5362675
6	WR	89	PEUGEOT		53002001	6	WR	87-89	PEUGEOT//207		53004455
8	CJ's	79	AUTO.	37.00	J5359382	6	WR	87-89	PEUGEOT//231		53004526
8	CJ's	79	T150	26.50	J5356500	6	WR	87-89	PEUGEOT//231		53005401*
8	CJ's	79	T18	30.25	J5356501	6	WR	87-89	AUTOMATIC//207		53004454
8	CJ's	80-81	T176-177	29.50	J5360986	6	WR	87-89	AUTOMATIC//231		53004525
8	CJ's	80-81	AUTO.	32.68	J5360985	8	CJ5	79	T150	18.00	J5356509
			<b>REAR</b>			8	CJ5	79	T18		J5356687
4	CJ5	80	SR4	13.90	J5360983	8	CJ7	79	T150	26.50	J8126508
4	CJ5	81	SR4	12.88	J5362276	8	CJ7	80	T176	23.60	J5360988
4	CJ5	82-83	T4, T5	12.88	J5362276	8	CJ7	80	SR4	21.10	J5360994
4	CJ7	80	AUTO.	20.80	J5360987	8	CJ7	81	AUTO.	22.26	J5362282
4	CJ7	80	SR4	23.60	J5360988	8	CJ7	81-86	T176-177	22.90	J5362281
4	CJ7	81	AUTO.	22.76	J5362282	8	CJ7	81	SR4	20.80	J5360987
4	CJ7	81-86	AUTO.	19.75	J5362280	8	CJ7	81-86	AUTO.	19.75	J5362280
4	CJ7	81-86	T176-177	22.90	J5362281						
4	CJ7	81-86	T4, T5	22.90	J5362281						
4	CJ7	81	SR4	20.80	J5360987						
4	CJ7	82	T176	26.20	J5362814						
4	CJ8	81	T176-177	32.88	J5362278						
4	CJ8	81	SR4	30.60	J5362277						
4	CJ8	81	AUTO.	32.26	J5362674						
4	CJ8	82-86	T4, T5	32.88	J5362278						
4	CJ8	82-83	T176	36.14	J5364017						
4	WR	87-89	AISIN//207		53004454						
4	WR	87-88	AISIN//231		53004454						

\* WITH 103" WHEELBASE.

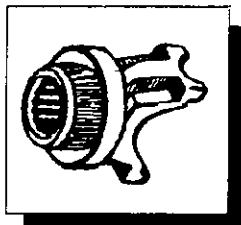
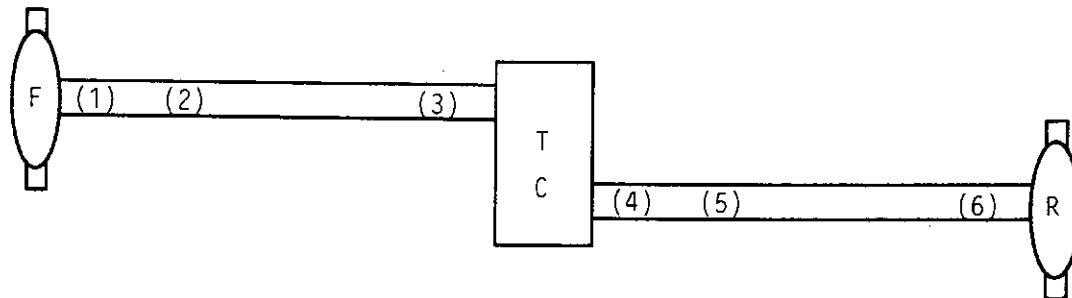

**9.404**

**YOKE, Axle Pinion (Front Axle) (1)**

4 Cyl : CJ, 1980 use J0935685  
 4 Cyl : CJ, 1981-86 use J8133241  
 4 Cyl : Wr, 1987-89 use 83503388  
  
 6 Cyl : CJ, 1979-80 use J0935685  
 6 Cyl : CJ, 1981-86 use J8133241  
 6 Cyl : CJ, 1987-89 use 83503388

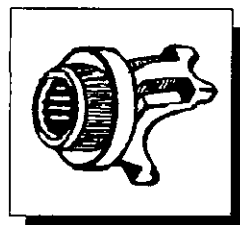

**18.870**

**YOKE, Transfer Case Rear Output (4)**

w/ Model 300 Transfer Case use J8131656  
 w/ Model 208 Transfer Case use J8130817  
 w/ Model 219 Transfer Case use J8130817  
 w/ Model 228 Transfer Case use J8130817  
 w/ Model 229 Transfer Case use J8130817

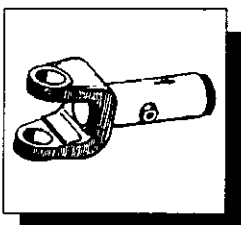

**9.104**

**YOKE, Front Propeller Shaft Universal Joint Sleeve (2)**

4 Cyl : CJ, 1980-86 use J8126400 1  
 4 Cyl : Wr, 1987-89 use 83501594 2  
  
 6 Cyl : CJ, 1979-86 use J8126400 1  
 6 Cyl : Wr, 1987-89 use 83501594 2

8 Cyl : CJ, 1979-81 use J8126400

**NOTE:** 1. 1985-86, WITH GREASE FITTING ON CAP USE 83501594.  
 2. FRONT SPICER MODEL. FOR GKN-BRD MODEL USE 83503117.

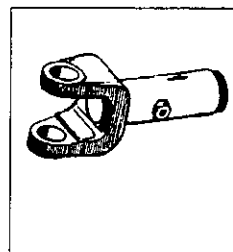

**9.104**

**YOKE, Rear Propeller Shaft Universal Joint Sleeve (5)**

4 Cyl : CJ, 1980-86 use J8126400  
 6 Cyl : CJ, 1979-86 use J8126400  
 8 Cyl : CJ, 1979-81 use J8126400

**WRANGLER**

W/ Dana Prop Shaft use 83502855  
 W/ GKN Prop Shaft use 83503114

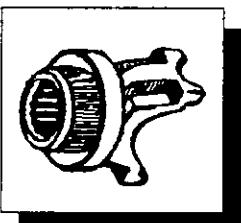

**18.870**

**YOKE, Transfer Case Front Output (3)**

w/ Model 300 Transfer Case use J8131656  
 w/ Model 208 Transfer Case use J8130818  
 w/ Model 219 Transfer Case use J8130818  
 w/ Model 228 Transfer Case use J8134272  
 w/ Model 229 Transfer Case use J8134272

**WRANGLER**

w/ Model 207 Transfer Case use 83502829  
 w/ Model 231 Transfer Case use 83502829

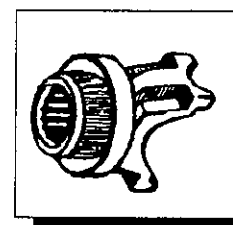

**9.104**

**YOKE, Axle Pinion (Rear Axle) (6)**

4 Cyl : CJ, 1980 use J8129201  
 4 Cyl : CJ, 1981-84 use J8132702 1  
 4 Cyl : CJ, 1985-86 use 83502058 2  
 4 Cyl : Wr, 1987-89 use 83500140

6 Cyl : CJ, 1979-80 use J8129201  
 6 Cyl : CJ, 1981-84 use J8132702 1  
 6 Cyl : CJ, 1985-86 use 83502058 2  
 6 Cyl : Wr, 1987-89 use 83500140

8 Cyl : CJ, 1979-80 use J8129201  
 8 Cyl : CJ, 1981 use J8132702

**NOTE:** 1. USED THROUGH 1985.  
 2. 1986, WITH 10 BOLT REAR AXLE COVER USE 83503114.

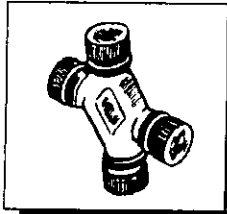

**9.107**

**SPIDER ASSY**, Propeller Shaft  
U-Joint Front & Rear Shaft

- 4 Cyl : CJ, 1980-86 use J8126614
- 4 Cyl : Wr, 1987-89 use J8126614
- 6 Cyl : CJ, 1979-86 use J8126614
- 6 Cyl : Wr, 1987-89 use J8126614
- 8 Cyl : CJ, 1979-81 use J8126614

NOTE: 1. FOR GKN-BRD MODEL USE 83503115.

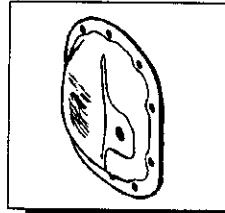

**9.307**

**COVER**, Front Axle Housing  
Model 30 (With Plug & Bolts)

- 4 Cyl : CJ, 1980-86 use J8126498
- 4 Cyl : Wr, 1987-89 use 83500194
- 6 Cyl : CJ, 1979-86 use J8126498
- 6 Cyl : Wr, 1987-89 use 83500194
- 8 Cyl : CJ, 1979-81 use J8126498

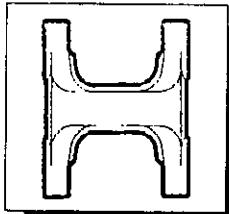

**9.110**

**YOKE**, Front Propeller Shaft (Center)

- 4 Cyl : CJ, 1980-86 use J8130296
- 6 Cyl : CJ, 1979-86 use J8130296
- 8 Cyl : CJ, 1979-81 use J8130296

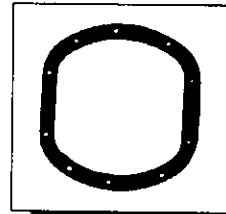

**9.307**

**GASKET**, Front Axle Housing Cover

- 4 Cyl : CJ, 1980-86 use J8120360
- 4 Cyl : Wr, 1987-89 use J8993317
- 6 Cyl : CJ, 1979-86 use J8120360
- 6 Cyl : CJ, 1987-89 use J8993317
- 8 Cyl : CJ, 1979-81 use J8120360

NOTE: 1. GASKET-IN-A-TUBE.



**9.110**

**YOKE KIT**, Front Propeller Shaft  
Socket (Rear)

- 4 Cyl : CJ, 1980-86 use J8130303
- 6 Cyl : CJ, 1979-86 use J8130303
- 8 Cyl : CJ, 1979-81 use J8130303

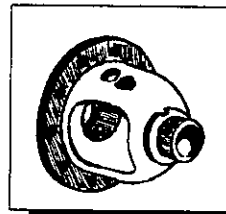

**9.321**

**CASE ASSY**, Front Axle Differential  
(W/ Side Gears & Washers)  
2:72, 2:73, 3:07, 3:31 & 3:54 Ratios

- 4 Cyl : CJ, 1980-86 use J8126513
- 6 Cyl : CJ, 1979-86 use J8126513
- 8 Cyl : CJ, 1979-81 use J8126513

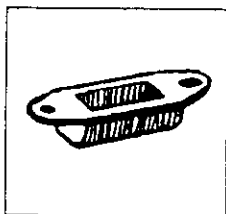

**9.304**

**BUMPER**, Front Axle

- 4 Cyl : CJ, 1980-86 use J5355483
- 4 Cyl : Wr, 1987-89 use 52040426
- 6 Cyl : CJ, 1979-86 use J5355483
- 6 Cyl : Wr, 1987-89 use 52040426
- 8 Cyl : CJ, 1979-81 use J5355483

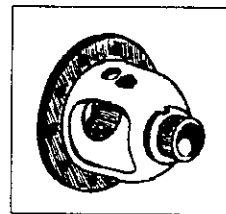

**9.321**

**CASE ASSY**, Front Axle Differential  
(W/ Side Gears & Washers)  
3:73, 4:09 & 4:10 Ratios

- 4 Cyl : CJ, 1980-86 use J8126495
- 6 Cyl : CJ, 1979-86 use J8126495
- 8 Cyl : CJ, 1979-81 use J8126495

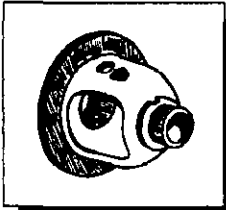

**9.324**

**CASE, Front Axle Differential**  
2:72, 2:73, 3:07, 3:31 & 3:54 Ratios

4 Cyl : CJ, 1980 use J8126515  
4 Cyl : Wr, 1987-89 use 83500168

6 Cyl : CJ, 1979-80 use J8126515  
6 Cyl : Wr, 1987-89 use 83500168

8 Cyl : CJ, 1979-80 use J8126515

NOTE: 1. INCLUDES BEARINGS, SHIMS & SCREWS.

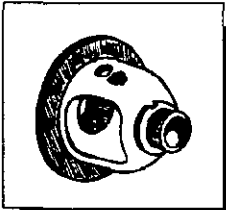

**9.324**

**CASE, Front Axle Differential**  
3:73, 4:09 & 4:10 Ratios

4 Cyl : CJ, 1980 use J8126496  
4 Cyl : Wr, 1987-89 use 83500169

6 Cyl : CJ, 1979-80 use J8126496  
6 Cyl : Wr, 1987-89 use 83500169

8 Cyl : CJ, 1979-80 use J8126496

NOTE: 1. INCLUDES BEARINGS, SHIMS & SCREWS.

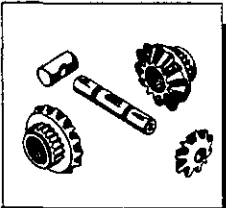

**9.327**

**GEAR SET, Front Axle Differential**  
Side - Model 30

4 Cyl : CJ, 1980-86 use J8126497  
4 Cyl : Wr, 1987-89 use 83500190

6 Cyl : CJ, 1979-86 use J8126497  
6 Cyl : Wr, 1987-89 use 83500190

8 Cyl : CJ, 1979-81 use J8126497

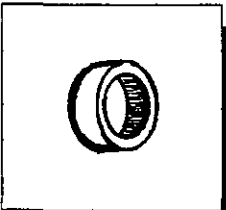

**9.341**

**BEARING KIT, Front Axle Differential**  
Side - Model 30  
(With 2 Bearings & 2 Cups)

4 Cyl : CJ, 1980-86 use J8126500  
4 Cyl : Wr, 1987-89 use J8126500

6 Cyl : CJ, 1979-86 use J8126500  
6 Cyl : Wr, 1987-89 use J8126500

8 Cyl : CJ, 1979-81 use J8126500

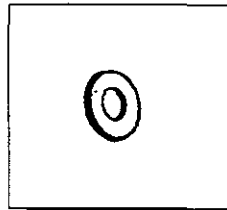

**9.345**

**SHIM SET, Front Axle Differential**  
Side Gear Bearing (W/ 8 Shims & Gskt)

4 Cyl : CJ, 1980-86 use J8126506  
4 Cyl : Wr, 1987-89 use 83500191

6 Cyl : CJ, 1979-86 use J8126506  
6 Cyl : Wr, 1987-89 use 83500191

8 Cyl : CJ, 1979-81 use J8126506

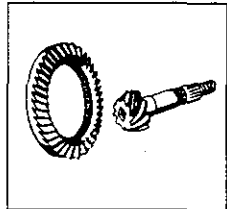

**9.350**

**GEAR SET, Front Axle (With Pinion)**  
Model 30 - 2:72 & 2:73 Ratios

4 Cyl : CJ, 1981-86 use J8133063

6 Cyl : CJ, 1981-86 use J8133063

8 Cyl : CJ, 1981 use J8133063

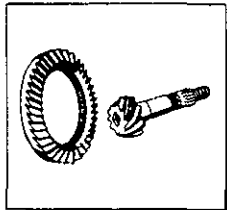

**9.350**

**GEAR SET, Front Axle (With Pinion)**  
Model 30 - 3:07 Ratio

4 Cyl : CJ, 1980 use J8130381  
4 Cyl : Wr, 1987-89 use 83500187

6 Cyl : CJ, 1979-80 use J8130381  
6 Cyl : Wr, 1987-89 use 83500187

8 Cyl : CJ, 1979-80 use J8130381

NOTE: 1. INCLUDES BEARINGS, SHIMS & SCREWS.

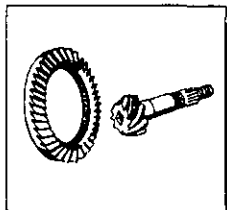

**9.350**

**GEAR SET, Front Axle (With Pinion)**  
Model 30 - 3:31 Ratio

4 Cyl : CJ, 1981-86 use J0945344

6 Cyl : CJ, 1981-86 use J0945344

8 Cyl : CJ, 1981 use J0945344

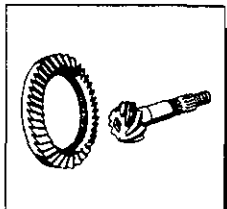

**9.350**

**GEAR SET, Front Axle (With Pinion)**  
Model 30 - 3:54 Ratio

4 Cyl : CJ, 1980-86 use J8126518  
4 Cyl : Wr, 1987-89 use 83502355<sup>1,2</sup>

6 Cyl : CJ, 1979-86 use J8126518  
6 Cyl : Wr, 1987-89 use 83502355<sup>1,2</sup>

8 Cyl : CJ, 1979-81 use J8126518

NOTE: 1. INCLUDES BEARINGS, SHIMS & SCREWS.  
2. W/ 3:55 RATIO USE 83504206.

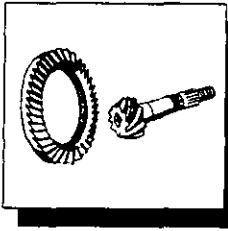

**9.350**

**GEAR SET, Front Axle (With Pinion)**  
Model 30 - 3:73 Ratio

- 4 Cyl : CJ, 1981 use J0945345
- 6 Cyl : CJ, 1981 use J0945345
- 8 Cyl : CJ, 1981 use J0945345

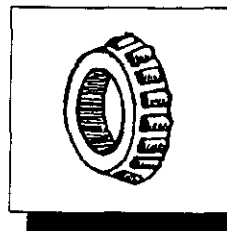

**9.352**

**BEARING, Front Axle Pinion**  
(Outer Rear)

- 4 Cyl : CJ, 1980-86 use J0052878
- 6 Cyl : CJ, 1979-86 use J0052878
- 8 Cyl : CJ, 1979-81 use J0052878

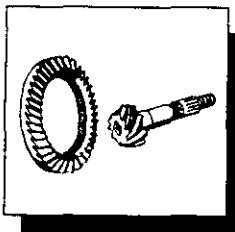

**9.350**

**GEAR SET, Front Axle (With Pinion)**  
Model 30 - 4:09 & 4:10 Ratios

- 4 Cyl : CJ, 1980-86 use J8126494
- 4 Cyl : Wr, 1987-89 use 83502353
- 6 Cyl : CJ, 1979-86 use J8126494
- 6 Cyl : Wr, 1987-89 use 83502353
- 8 Cyl : CJ, 1979-81 use J8126494

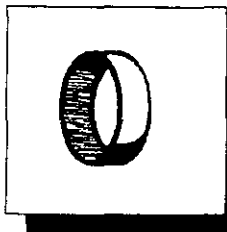

**9.355**

**CUP, Front Axle Pinion Bearing**  
(Outer Rear)

- 4 Cyl : CJ, 1980-86 use J0052879
- 6 Cyl : CJ, 1979-86 use J0052879
- 8 Cyl : CJ, 1979-81 use J0052879

**NOTE: 1. INCLUDES BEARINGS, SHIMS & SCREWS.**



**9.350**

**NUT, Front Axle Pinion**

- 4 Cyl : CJ, 1980-86 use J0801367
- 4 Cyl : Wr, 1987-89 use J0801367
- 6 Cyl : CJ, 1979-86 use J0801367
- 6 Cyl : Wr, 1987-89 use J0801367
- 8 Cyl : CJ, 1979-81 use J0801367

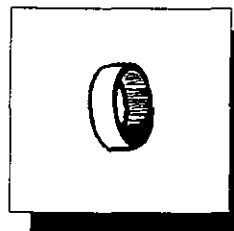

**9.355**

**BEARING KIT, Front Axle Pinion Kit**  
(With Bearing & Cone) - Inner

- 4 Cyl : CJ, 1980-86 use J8126499
- 4 Cyl : Wr, 1987-89 use J8126499
- 6 Cyl : CJ, 1979-86 use J8126499
- 6 Cyl : CJ, 1987-89 use J8126499
- 8 Cyl : CJ, 1979-81 use J8126499

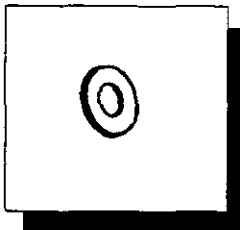

**9.350**

**SHIM SET, Front Axle Pinion**

- 4 Cyl : CJ, 1980-86 use J8126503
- 4 Cyl : Wr, 1987-89 use 83500192
- 6 Cyl : CJ, 1979-86 use J8126503
- 6 Cyl : Wr, 1987-89 use 83500192
- 8 Cyl : CJ, 1979-81 use J8126503

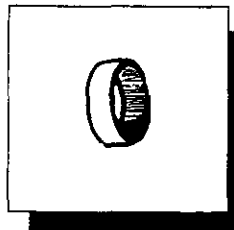

**9.355**

**BEARING KIT, Front Axle Pinion Kit**  
(With Bearing & Cone) - Outer

- 4 Cyl : CJ, 1980-86 use J8124052
- 4 Cyl : Wr, 1987-89 use J8124052
- 6 Cyl : CJ, 1979-86 use J8124052
- 6 Cyl : Wr, 1987-89 use J8124052
- 8 Cyl : CJ, 1979-81 use J8124052



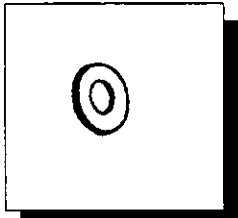

**9.357**

**SHIM SET**, Front Axle Drive Pinion Adjusting

- 4 Cyl : CJ, 1980-86 use J8126502
- 6 Cyl : CJ, 1979-86 use J8126502
- 8 Cyl : CJ, 1979-81 use J8126502



**9.368**

**SHAFT ASSY**, Front Axle (W/ Inner Slinger, U-Joint, Gskt & Snap Ring) **Left**

- 4 Cyl : CJ, 1980-81 use J8127599
- 4 Cyl : CJ, 1982-86 use J8134293
- 4 Cyl : Wr, 1987-89 use 53000684
- 6 Cyl : CJ, 1979-81 use J8127599
- 6 Cyl : CJ, 1982-86 use J8134293
- 6 Cyl : Wr, 1987-89 use 53000684
- 8 Cyl : CJ, 1979-81 use J8127599

NOTE: 1. 1982-83, FOR CJ-5 USE J8127599.

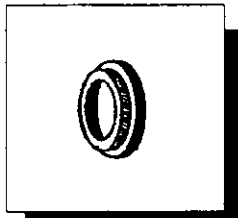

**9.364**

**OIL SEAL**, Front Axle Pinion Bearing

- 4 Cyl : CJ, 1980-86 use J0998092
- 4 Cyl : Wr, 1987-89 use J0998092
- 6 Cyl : CJ, 1979-86 use J0998092
- 6 Cyl : Wr, 1987-89 use J0998092
- 8 Cyl : CJ, 1979-81 use J0998092

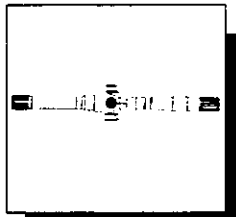

**9.368**

**SHAFT ASSY**, Front Axle (W/ Inner Slinger, U-Joint, Gskt & Snap Ring) **Right**

- 4 Cyl : CJ, 1980-81 use J8127598
- 4 Cyl : CJ, 1982-86 use J8134294
- 4 Cyl : Wr, 1987-89 use 53000224
- 6 Cyl : CJ, 1979-81 use J8127598
- 6 Cyl : CJ, 1982-86 use J8134294
- 6 Cyl : Wr, 1987-89 use 53000224
- 8 Cyl : CJ, 1979-81 use J8127598

NOTE: 1. 1982-83, FOR CJ-5 USE J8127598.

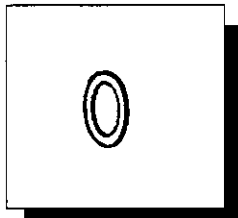

**9.364**

**SLINGER**, Front Axle Pinion Bearing Oil - **Inner Front**

- 4 Cyl : CJ, 1980-86 use J0916372
- 4 Cyl : Wr, 1987-89 use J0916372
- 6 Cyl : CJ, 1979-86 use J0916372
- 6 Cyl : Wr, 1987-89 use J0916372
- 8 Cyl : CJ, 1979-81 use J0916372

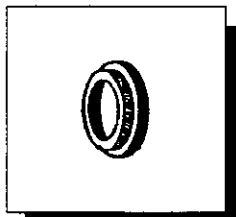

**9.368**

**OIL SEAL**, Front Axle Shaft Inner

- 4 Cyl : CJ, 1980-86 use J8121781
- 4 Cyl : Wr, 1987-89 use J8121781
- 6 Cyl : CJ, 1979-86 use J8121781
- 6 Cyl : Wr, 1987-89 use J8121781
- 8 Cyl : CJ, 1979-81 use J8121781

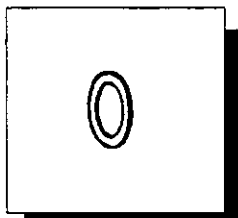

**9.364**

**SLINGER**, Front Axle Pinion Bearing Oil - **Outer Rear**

- 4 Cyl : CJ, 1980-86 use J0636566
- 4 Cyl : Wr, 1987-89 use J0636566
- 6 Cyl : CJ, 1979-86 use J0636566
- 6 Cyl : Wr, 1987-89 use J0636566
- 8 Cyl : CJ, 1979-81 use J0636566

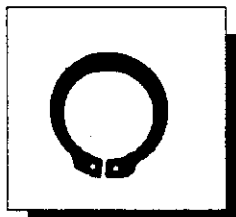

**9.368**

**SNAP RING**, Front Axle Shaft

- 4 Cyl : CJ, 1980-86 use J0649778
- 6 Cyl : CJ, 1979-86 use J0649778
- 8 Cyl : CJ, 1979-81 use J0649778

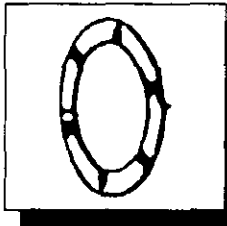

**9.368**

**GASKET, Front Axle Shaft Flange**

- 4 Cyl : CJ, 1980 use J0649784
- 4 Cyl : CJ, 1981-86 use J5362001
- 6 Cyl : CJ, 1979-80 use J0649784
- 6 Cyl : CJ, 1981-86 use J5362001
- 8 Cyl : CJ, 1979-80 use J0649784
- 8 Cyl : CJ, 1981 use J5362001

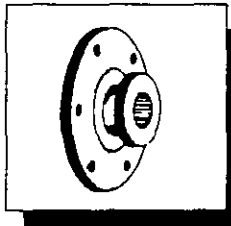

**9.369**

**FLANGE, Front Axle Shaft**

- 4 Cyl : CJ, 1980 use J0999396
- 4 Cyl : CJ, 1981-86 use J5362000
- 6 Cyl : CJ, 1979-80 use J0999396
- 6 Cyl : CJ, 1981-86 use J5362000
- 8 Cyl : CJ, 1979-80 use J0999396
- 8 Cyl : CJ, 1981 use J5362000

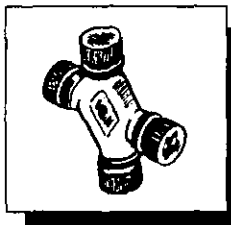

**9.370**

**SPIDER ASSY, Front Axle Shaft U-Joint**

- 4 Cyl : CJ, 1980-86 use J8126637
- 4 Cyl : Wr, 1987-89 use J8126637
- 6 Cyl : CJ, 1979-86 use J8126637
- 6 Cyl : Wr, 1987-89 use J8126637
- 8 Cyl : CJ, 1979-81 use J8126637

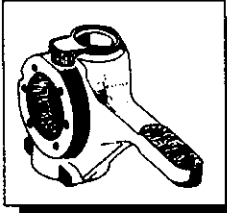

**10.004**  
**(9.390)**

**KNUCKLE, Steering - Left**

4 Cyl : CJ, 1980-86 use J8129655  
4 Cyl : Wr, 1987-89 use 53000625

6 Cyl : CJ, 1979-86 use J8129655  
6 Cyl : Wr, 1987-89 use 53000625

8 Cyl : CJ, 1979-81 use J8129655

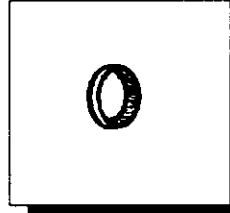

**10.004**

**OIL SEAL, Front Steering Spindle**  
2-3/4" O.D.

4 Cyl : CJ, 1980-86 use J8127350

6 Cyl : CJ, 1979-86 use J8127350

8 Cyl : CJ, 1979-81 use J8127350

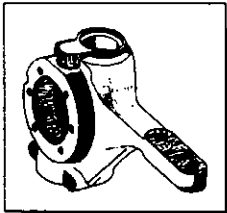

**10.004**  
**(9.390)**

**KNUCKLE, Steering - Right**

4 Cyl : CJ, 1980-86 use J8129654  
4 Cyl : Wr, 1987-89 use 53000626

6 Cyl : CJ, 1979-86 use J8129654  
6 Cyl : Wr, 1987-89 use 53000626

8 Cyl : CJ, 1979-81 use J8129654

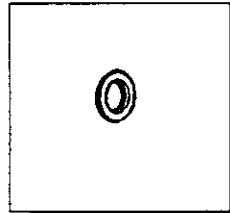

**10.004**

**SPACER, Front Steering Spindle**  
3" O.D.

4 Cyl : CJ, 1980-86 use J8127348

6 Cyl : CJ, 1979-86 use J8127348

8 Cyl : CJ, 1979-81 use J8127348

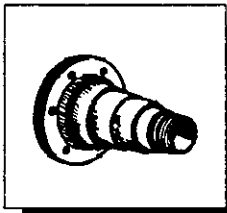

**10.004**

**SPINDLE ASSY, Steering**  
(With Seal, Bearing & Spacer)

4 Cyl : CJ, 1980-86 use J8128147

6 Cyl : CJ, 1979-86 use J8128147

8 Cyl : CJ, 1979-81 use J8128147

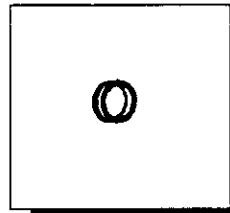

**10.004**

**SEAL, Front Spindle Bearing - "V"Type**

4 Cyl : CJ, 1980-86 use J8121397

6 Cyl : CJ, 1979-86 use J8121397

8 Cyl : CJ, 1979-81 use J8121397

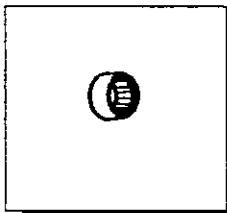

**10.004**

**BEARING KIT, Steering Spindle**  
(With Seals & Spacer)

4 Cyl : CJ, 1980-86 use J8127356

6 Cyl : CJ, 1979-86 use J8127356

8 Cyl : CJ, 1979-81 use J8127356

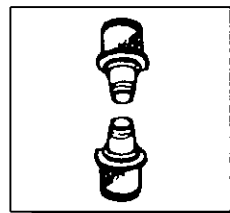

**10.006**

**STUD KIT, Steering Knuckle Ball**  
(Including Attaching Parts)

4 Cyl : CJ, 1980-86 use J8124333

6 Cyl : CJ, 1979-86 use J8124333

8 Cyl : CJ, 1979-81 use J8124333



**10.006**

**STUD, Steering Knuckle Ball - Upper**

4 Cyl : CJ, 1980-86 use J8122495  
 6 Cyl : CJ, 1979-86 use J8122495  
 8 Cyl : CJ, 1979-81 use J8122495

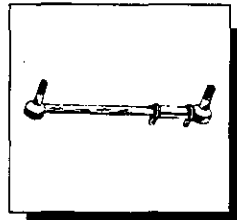

**10.118**

**ROD ASSY, Steering Arm to Steering Arm Tie (With Ends) L.H.D.**

4 Cyl : CJ, 1980-81 use J5350586  
 4 Cyl : CJ, 1982-86 use J8134295  
 6 Cyl : CJ, 1979-81 use J5350586  
 6 Cyl : CJ, 1982-86 use J8134295  
 8 Cyl : CJ, 1979-81 use J5350586

NOTE: 1. 1982-83, FOR CJ-5 USE J5350586.



**10.006**

**STUD, Steering Knuckle Ball - Lower**

4 Cyl : CJ, 1980-86 use J8122496  
 6 Cyl : CJ, 1979-86 use J8122496  
 8 Cyl : CJ, 1979-81 use J8122496

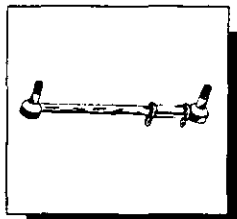

**10.118**

**ROD ASSY, Pitman Arm to Steering Arm Tie (With Ends)**

4 Cyl : CJ, 1980-83 use J5356105  
 6 Cyl : CJ, 1979-83 use J5356105  
 8 Cyl : CJ, 1979-81 use J5356105

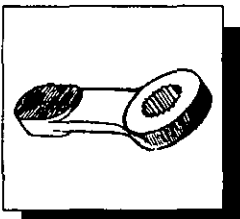

**10.104**

**ARM, Steering Linkage Pitman (L.H.D.) Without Power Steering**

4 Cyl : CJ, 1980-86 use J5356106  
 4 Cyl : Wr, 1987-89 use 52040110  
 6 Cyl : CJ, 1979-86 use J5356106  
 6 Cyl : Wr, 1987-89 use 52040110  
 8 Cyl : CJ, 1979-81 use J5356106



**10.126**

**TIE ROD END ASSY, Steering Arm to Steering Arm (3-1/8" Long) Left**

4 Cyl : CJ, 1980-86 use J0921317  
 4 Cyl : Wr, 1987-89 use 52000598  
 6 Cyl : CJ, 1979-86 use J0921317  
 6 Cyl : Wr, 1987-89 use 52000598  
 8 Cyl : CJ, 1979-81 use J0921317

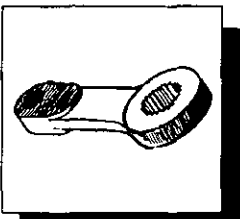

**10.104**

**ARM, Steering Linkage Pitman (L.H.D.) With Power Steering**

4 Cyl : CJ, 1980-86 use J5356104  
 4 Cyl : Wr, 1987-89 use 52040112  
 6 Cyl : CJ, 1979-86 use J5356104  
 6 Cyl : Wr, 1987-89 use 52040112  
 8 Cyl : CJ, 1979-81 use J5356104



**10.126**

**TIE ROD END ASSY, Steering Arm to Steering Arm (3-1/8" Long) Right**

4 Cyl : CJ, 1980-86 use J0920535  
 4 Cyl : Wr, 1987-89 use 52000599  
 6 Cyl : CJ, 1979-86 use J0920535  
 6 Cyl : Wr, 1987-89 use 52000599  
 8 Cyl : CJ, 1979-81 use J0920535



**10.126**

**TIE ROD END ASSY**, Pitman Arm to Steering Arm (3-1/8" Long)

4 Cyl : CJ, 1980-86 use J0921317  
4 Cyl : Wr, 1987-89 use 52002541

6 Cyl : CJ, 1979-86 use J0921317  
6 Cyl : Wr, 1987-89 use 52002541

8 Cyl : CJ, 1979-81 use J0921317

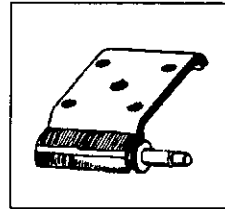

**10.260**

**BRACKET**, Front Suspension Sway Stabilizer Connecting Link to Spring Tie Plate

**LEFT**

4 Cyl : CJ, 1980-86 use J5359011  
6 Cyl : CJ, 1979-86 use J5359011  
8 Cyl : CJ, 1979-81 use J5359011

**RIGHT**

4 Cyl : CJ, 1980-86 use J5359012  
6 Cyl : CJ, 1979-86 use J5359012  
8 Cyl : CJ, 1979-81 use J5359012

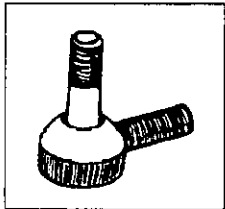

**10.126**

**TIE ROD END ASSY**, Pitman Arm to Steering Arm

4 Cyl : CJ, 1980-81 use J0991744  
4 Cyl : CJ, 1982-86 use J8134350  
4 Cyl : Wr, 1987-89 use 52002540

6 Cyl : CJ, 1979-81 use J0991744  
6 Cyl : CJ, 1982-86 use J8134350  
6 Cyl : Wr, 1987-89 use 52002540

8 Cyl : CJ, 1979-81 use J0991744

NOTE: 1. 1982-83, FOR CJ-5 (23.94" LONG) USE J0991744.

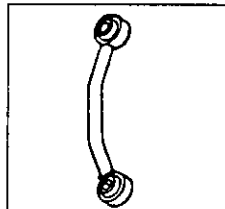

**10.260**

**LINK**, Front Suspension Sway Stabilizer to Spring Tie Plate Connecting

4 Cyl : CJ, 1980-86 use J5364122

6 Cyl : CJ, 1979-86 use J5364122

8 Cyl : CJ, 1979-81 use J5364122

NOTE: 1. WITH HEAVY DUTY SPRINGS USE J5364121.

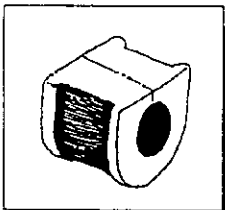

**10.260**

**CUSHION**, Front Suspension Sway Stabilizer to Frame

4 Cyl : CJ, 1980-86 use J5361674  
4 Cyl : Wr, 1987-89 use 52003143

6 Cyl : CJ, 1979 use J5355315  
6 Cyl : CJ, 1980-86 use J5361674  
6 Cyl : Wr, 1987-89 use 52003143

8 Cyl : CJ, 1979 use J5355315  
8 Cyl : CJ, 1980-81 use J5361674

NOTE: 1. WITH 13/16" DIAMETER & VERTICAL SLIT AND USED WITH BAR #5355327. J5361674 HAS 7/8" DIAMETER & HORIZONTAL SLIT AND USED WITH BAR #5361654.

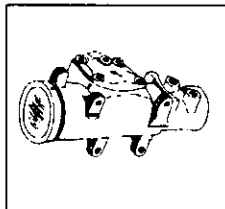

**10.290**

**GEAR ASSY**, Steering Without Power Steering

4 Cyl : CJ, 1980-86 use J0994509  
4 Cyl : Wr, 1987-89 use 52000089

6 Cyl : CJ, 1979-86 use J0994509  
6 Cyl : Wr, 1987-89 use 52000089

8 Cyl : CJ, 1979-81 use J0994509

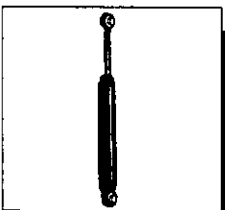

**10.260**

**DAMPER**, Steering (Shock Style)

4 Cyl : CJ, 1980-86 use J0940105  
4 Cyl : Wr, 1987-89 use 3236097HD

6 Cyl : CJ, 1979-86 use J0940105  
6 Cyl : Wr, 1987-89 use 3236097HD

8 Cyl : CJ, 1979-81 use J0940105

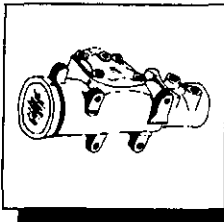

**10.290**

**GEAR ASSY, Steering**  
With Power Steering

4 Cyl : CJ, 1980 use J5360092  
4 Cyl : CJ, 1981-86 use J5363231  
4 Cyl : Wr, 1987-89 use 52040101

6 Cyl : CJ, 1979 use J0994508  
6 Cyl : CJ, 1980 use J5360092  
6 Cyl : CJ, 1981-86 use J5363231  
6 Cyl : Wr, 1987-89 use 52040101

8 Cyl : CJ, 1979 use J0994508  
8 Cyl : CJ, 1980 use J5360092  
8 Cyl : CJ, 1981 use J5363231

**NOTE:** 1. 1981, WITH CONSTANT RATIO GEAR AND STAMPED VJ USE J5360092.

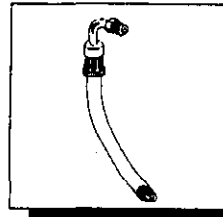

**10.470**

**HOSE, Power Steering Pump to Steering Gear Pressure**

4 Cyl : CJ, 1980 use J5370020  
4 Cyl : CJ, 1981 use J5370045  
4 Cyl : CJ, 1982-83 use J5363659  
4 Cyl : CJ, 1984-86 use J5364672  
4 Cyl : Wr, 1987-89 use 52040123

6 Cyl : CJ, 1979 use J5357191  
6 Cyl : CJ, 1980 use J5370018  
6 Cyl : CJ, 1981 use J5370112  
6 Cyl : CJ, 1982-86 use J5363661  
6 Cyl : Wr, 1987 use 52002459  
6 Cyl : Wr, 1988-89 use 52003687

8 Cyl : CJ, 1979 use J5357188  
8 Cyl : CJ, 1980-81 use J5370016

**NOTE:** 1. WITH AMC ENGINE USE J5364672.

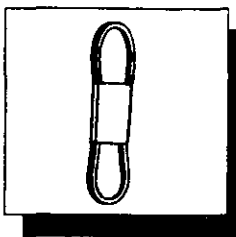

**10.455**

**BELT, Power Steering Pump**

4 Cyl : CJ, 1980-86 use G9433651  
4 Cyl : Wr, 1987-89 use J3226936

6 Cyl : CJ, 1979-86 use J3226936  
6 Cyl : Wr, 1987-89 use J3226936

8 Cyl : CJ, 1979-81 use J3227692

**NOTE:** 1. FOR 54" CIRCUMFERENCE. FOR 53-1/4" CIRCUMFERENCE USE J3229862.

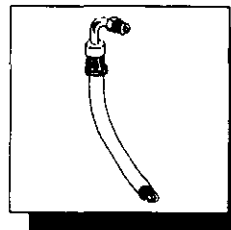

**10.470**

**HOSE, Power Steering Pump Reservoir to Steering Gear Return**

4 Cyl : CJ, 1980-81 use J5370021  
4 Cyl : CJ, 1982-83 use J5363660  
4 Cyl : CJ, 1984-86 use J5364673  
4 Cyl : Wr, 1987-89 use 52040125

6 Cyl : CJ, 1979 use J5357190  
6 Cyl : CJ, 1980 use J5370019  
6 Cyl : CJ, 1981 use J5370111  
6 Cyl : CJ, 1982-86 use J5363662  
6 Cyl : Wr, 1987-89 use 52002460

8 Cyl : CJ, 1979 use J5357189  
8 Cyl : CJ, 1980-81 use J5370017

**NOTE:** 1. WITH AMC ENGINE USE J5364673.

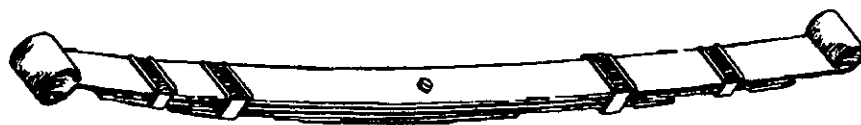

11.070

**SPRING ASSY, Front Leaf**  
(W/O Bushings) - 4 Leaf - Wrangler-YJ

4 Cyl : Wr, 1987-89 use 52003207<sup>1</sup>

6 Cyl : Wr, 1987-89 use 52003206<sup>1</sup>

NOTE: 1. FOR HEAVY DUTY USE 52003448.

11.070

**SPRING ASSY, Front Leaf**  
(W/O Bushings) - 4 Leaf - CJ-5

4 Cyl : CJ, 1980 use J5361024

4 Cyl : CJ, 1981-83 use J5363227<sup>1</sup>

6 Cyl : CJ, 1979 use J5354890

6 Cyl : CJ, 1980 use J5363228<sup>2</sup>

8 Cyl : CJ, 1979-81 use J5355581

8 Cyl : CJ, 1981 use J5363229<sup>3</sup>

**NOTE:**

1. 1981, PRIOR TO CAR SEQUENCE NO. 057506 USE J5361024.

2. 1981, PRIOR TO CAR SEQUENCE NO. 057506, W/O HARDTOP USE J5354890. WITH HARDTOP USE J5355581.

3. PRIOR TO CAR SEQUENCE NO. 057506 USE J5355581.

11.070

**SPRING ASSY, Front Leaf**  
(W/O Bushings) - 5 Leaf - CJ-5

4 Cyl : CJ, 1981 use J5363297

4 Cyl : CJ, 1982 use J5363851

6 Cyl : CJ, 1981 use J5363298

6 Cyl : CJ, 1982 use J5363852

11.070

**SPRING ASSY, Front Leaf**  
(W/O Bushings) - 5 Leaf - CJ-7,8

4 Cyl : CJ, 1981 use J5363298

4 Cyl : CJ, 1982 use J5363852

11.070

**SPRING ASSY, Front Leaf**  
(W/O Bushings) - 4 Leaf - CJ-7,8

4 Cyl : CJ, 1980 use J5361024

4 Cyl : CJ, 1981 use J5363228<sup>1</sup>

4 Cyl : CJ, 1982-86 use J5363632

6 Cyl : CJ, 1979-80 use J5354890

6 Cyl : CJ, 1981-86 use J5363229<sup>2,3</sup>

8 Cyl : CJ, 1979-80 use J5355581

8 Cyl : CJ, 1981 use J5363230<sup>4</sup>

**NOTE:**

1. 1981, PRIOR TO CAR SEQUENCE NO. 057506 USE J5361024.

2. 1981, PRIOR TO CAR SEQUENCE NO. 057506, W/O HARDTOP USE J5354890. WITH HARDTOP USE J5355581.

3. FOR LIMITED OR SOFT RIDE MODEL USE J5363933.

4. PRIOR TO CAR SEQUENCE NO. 057506 USE J5355581.

11.070

**SPRING ASSY, Front Leaf**  
(W/O Bushings) - 6 Leaf - CJ-5

4 Cyl : CJ, 1980-81 use J5361275

4 Cyl : CJ, 1982-83 use J5364385

6 Cyl : CJ, 1979-80 use J5358939

6 Cyl : CJ, 1981 use J5363226

6 Cyl : CJ, 1982-83 use J5364385

8 Cyl : CJ, 1979-80 use J5358939

11.070

**SPRING ASSY, Front Leaf**  
(W/O Bushings) - 6 Leaf - CJ-7,8

4 Cyl : CJ, 1980-81 use J5361275

4 Cyl : CJ, 1982-86 use J5364385

6 Cyl : CJ, 1979-80 use J5358939

6 Cyl : CJ, 1981 use J5363226

6 Cyl : CJ, 1982-86 use J5363850

8 Cyl : CJ, 1979-80 use J5358939

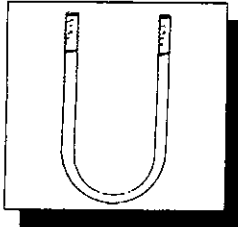

11.088

**U-BOLT, Front & Rear Spring**

4 Cyl : CJ, 1980-86 use J8130369<sup>1</sup>  
 4 Cyl : Wr, 1987-89 use J8130369<sup>1</sup>

6 Cyl : CJ, 1979 use J5353994<sup>1</sup>  
 6 Cyl : CJ, 1980-86 use J8130369<sup>1</sup>  
 6 Cyl : Wr, 1987-89 use J8130369<sup>1</sup>

8 Cyl : CJ, 1979 use J5353994<sup>1</sup>  
 8 Cyl : CJ, 1980-81 use J8130369

NOTE: 1. FOR 3.75" WIDE U-BOLT USE J8130370 (J8130369 IS 3.06" WIDE).

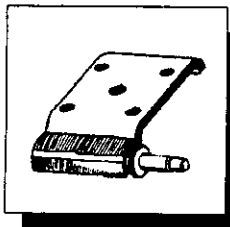

11.088

**PLATE, Front Leaf Spring to Axle U-Bolt Tie - Left**

4 Cyl : CJ, 1980-86 use J5359011  
 4 Cyl : Wr, 1987-89 use 52040407

6 Cyl : CJ, 1979-86 use J5359011  
 6 Cyl : Wr, 1987-89 use 52040407

8 Cyl : CJ, 1979-81 use J5359011

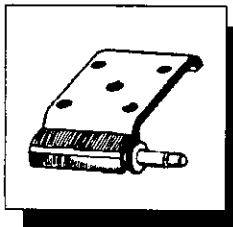

11.088

**PLATE, Front Leaf Spring to Axle U-Bolt Tie - Right**

4 Cyl : CJ, 1980-86 use J5359012  
 4 Cyl : Wr, 1987-89 use 52040348

6 Cyl : CJ, 1979-86 use J5359012  
 6 Cyl : Wr, 1987-89 use 52040348

8 Cyl : CJ, 1979-81 use J5359012

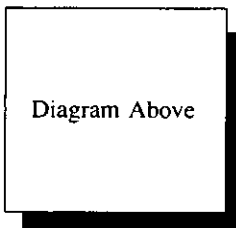

11.100

**SPRING ASSY, Rear Leaf (W/O Bushings) - 4 Leaf**

4 Cyl : CJ, 1980 use J5361025  
 4 Cyl : CJ, 1981 use J5356424

6 Cyl : CJ, 1979-80 use J5356424

8 Cyl : CJ, 1979-80 use J5356424



Diagram Above

11.100

**SPRING ASSY, Rear Leaf (W/O Bushings) - 5 Leaf - CJ-5,7,8, YJ**

4 Cyl : CJ, 1980-82 use J5363330<sup>1,2</sup>  
 4 Cyl : Wr, 1987-89 use 52003208<sup>3</sup>

6 Cyl : CJ, 1979-80 use J5363935  
 6 Cyl : Wr, 1987-89 use 52003208<sup>3</sup>

NOTE: 1. 1981, PRIOR TO CAR SEQUENCE NO. 057506, WITH HARDTOP USE J5356425.  
 2. 1982-86, FOR LIMITED OR SOFT RIDE MODEL USE J5363636.  
 3. WITH HARDTOP USE 52003209.

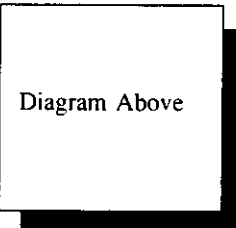

Diagram Above

11.100

**SPRING ASSY, Rear Leaf (W/O Bushings) - 6 Leaf - CJ-5,7,8, YJ**

4 Cyl : CJ, 1980 use J5358940  
 4 Cyl : CJ, 1981-86 use J5363332<sup>1</sup>  
 4 Cyl : Wr, 1987-89 use 52003449

6 Cyl : CJ, 1979-80 use J5358940  
 6 Cyl : CJ, 1981-86 use J5363332<sup>2</sup>  
 6 Cyl : Wr, 1987-89 use 52003449

8 Cyl : CJ, 1979-80 use J5358940  
 8 Cyl : CJ, 1981 use J5363333<sup>3</sup>

NOTE: 1. 1982-86, WITH HARDTOP USE J5363853.  
 2. WITH HARDTOP USE J5363331. FOR CJ-8 USE J5363331.  
 3. FOR CJ-5 USE J5363331.



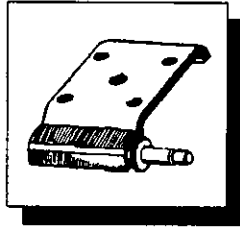

**11.136**

**PLATE, Rear Leaf Spring to Axle U-Bolt Tie - Left**

4 Cyl : CJ, 1980-81 use J5359007  
 4 Cyl : CJ, 1982-86 use J5363439  
 4 Cyl : Wr, 1987-89 use 52003150

6 Cyl : CJ, 1979-80 use J5359007  
 6 Cyl : CJ, 1981-86 use J5363439  
 6 Cyl : Wr, 1987-89 use 52003150

8 Cyl : CJ, 1979-80 use J5359007  
 8 Cyl : CJ, 1981 use J5363439

NOTE: 1. 1986, w/ 10 BOLT REAR AXLE COVER USE 55052681.

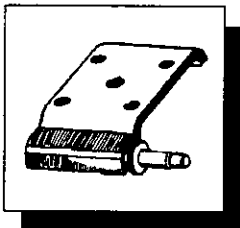

**11.136**

**PLATE, Rear Leaf Spring to Axle U-Bolt Tie - Right**

4 Cyl : CJ, 1980-81 use J5359008  
 4 Cyl : CJ, 1982-86 use J5363440  
 4 Cyl : Wr, 1987-89 use 52003150

6 Cyl : CJ, 1979-80 use J5359008  
 6 Cyl : CJ, 1981-86 use J5363440  
 6 Cyl : Wr, 1987-89 use 52003150

8 Cyl : CJ, 1979-80 use J5359008  
 8 Cyl : CJ, 1981 use J5363440

NOTE: 1. 1986, w/ 10 BOLT REAR AXLE COVER USE 55052682.

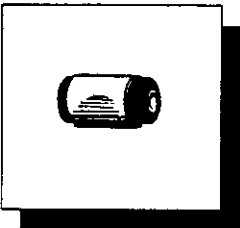

**11.144**

**BUSHING, Front Spring - Rear**

4 Cyl : CJ, 1980-86 use J5353851  
 4 Cyl : Wr, 1987-89 use 52002551

6 Cyl : CJ, 1979-86 use J5353851  
 6 Cyl : Wr, 1987-89 use 52002551

8 Cyl : CJ, 1979-81 use J5353851

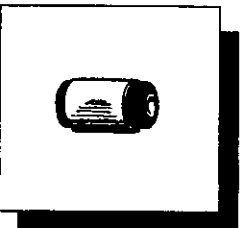

**11.144**

**BUSHING, Rear Spring - Front**

4 Cyl : CJ, 1980-86 use J5355369  
 4 Cyl : Wr, 1987-89 use 52002551

6 Cyl : CJ, 1979-86 use J5355369  
 6 Cyl : Wr, 1987-89 use 52002551

8 Cyl : CJ, 1979-81 use J5355369

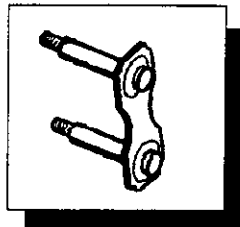

**11.170**

**SHACKLE, Front Leaf Spring**

4 Cyl : CJ, 1980-82 use J5357620

6 Cyl : CJ, 1979-82 use J5357620

8 Cyl : CJ, 1979-81 use J5357620

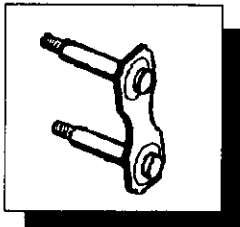

**11.170**

**SHACKLE, Rear Leaf Spring**

4 Cyl : CJ, 1980-82 use J5357499

6 Cyl : CJ, 1979-82 use J5357499

8 Cyl : CJ, 1979-81 use J5357499

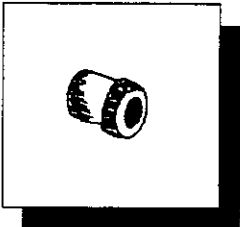

**11.170**

**BUSHING, Leaf Spring Shackle Front Spring**

4 Cyl : CJ, 1980-86 use J5355966  
 4 Cyl : Wr, 1987-89 use 52002552

6 Cyl : CJ, 1979-86 use J5355966  
 6 Cyl : Wr, 1987-89 use 52002552

8 Cyl : CJ, 1979-81 use J5355966

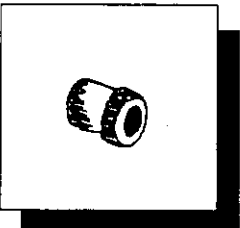

**11.170**

**BUSHING, Leaf Spring Shackle Rear Spring**

4 Cyl : CJ, 1980-86 use J5355841  
 4 Cyl : Wr, 1987-89 use 52002552

6 Cyl : CJ, 1979-86 use J5355841  
 6 Cyl : Wr, 1987-89 use 52002552

8 Cyl : CJ, 1979-81 use J5355841

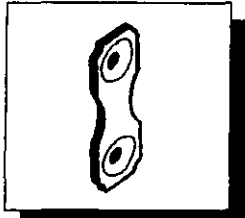

11.170

**SHACKLE PLATE**, Front & Rear

4 Cyl : CJ, 1980-82 use J5357497  
 4 Cyl : CJ, 1983-86 use J5364404  
 4 Cyl : Wr, 1987-89 use 52040415

6 Cyl : CJ, 1979-82 use J5357497  
 6 Cyl : CJ, 1983-86 use J5364404  
 6 Cyl : Wr, 1987-89 use 52040415

8 Cyl : CJ, 1979-81 use J5357497

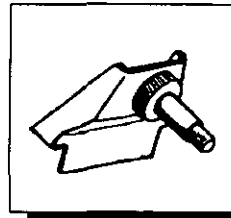

11.201

**BRACKET**, Front Shock to Frame Left

4 Cyl : CJ, 1980-81 use J8126587  
 4 Cyl : CJ, 1982-86 use J5363319  
 4 Cyl : Wr, 1987-89 use 52040325

6 Cyl : CJ, 1979-81 use J8126587  
 6 Cyl : CJ, 1982-86 use J5363319  
 6 Cyl : Wr, 1987-89 use 52040325

8 Cyl : CJ, 1979-81 use J8126587

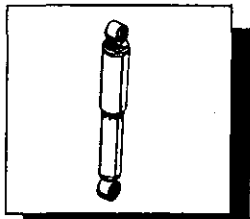

11.200

**SHOCK ASSY**, Front  
 With Attaching Parts - STD

4 Cyl : CJ, 1980 use J5353216  
 4 Cyl : CJ, 1981 use J8133289  
 4 Cyl : CJ, 1982-86 use J8134100  
 4 Cyl : Wr, 1987-89 use 83502866

6 Cyl : CJ, 1979-80 use J5353216  
 6 Cyl : CJ, 1981 use J8133289  
 6 Cyl : CJ, 1982-86 use J8134100  
 6 Cyl : Wr, 1987-89 use 83502866

8 Cyl : CJ, 1979-80 use J5353216  
 8 Cyl : CJ, 1981 use J8133289

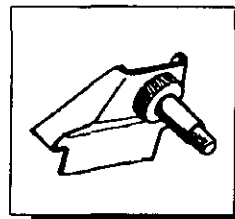

11.201

**BRACKET**, Front Shock to Frame Right

4 Cyl : CJ, 1980-81 use J8126587  
 4 Cyl : CJ, 1982-86 use J5363318  
 4 Cyl : Wr, 1987-89 use 52040325

6 Cyl : CJ, 1979-81 use J8126587  
 6 Cyl : CJ, 1982-86 use J5363318  
 6 Cyl : Wr, 1987-89 use 52040325

8 Cyl : CJ, 1979-81 use J8126587

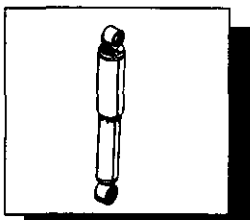

11.200

**SHOCK ASSY**, Front  
 With Attaching Parts - Heavy

4 Cyl : CJ, 1980 use J5361745  
 4 Cyl : CJ, 1981 use J8133290  
 4 Cyl : CJ, 1982-86 use J8134101  
 4 Cyl : Wr, 1987-89 use 83502836

6 Cyl : CJ, 1979 use J5355684  
 6 Cyl : CJ, 1980 use J5361745  
 6 Cyl : CJ, 1981 use J8133290  
 6 Cyl : CJ, 1982-86 use J8134101  
 6 Cyl : Wr, 1987-89 use 83502836

8 Cyl : CJ, 1979 use J5355684  
 8 Cyl : CJ, 1980 use J5361745  
 8 Cyl : CJ, 1981 use J8133290

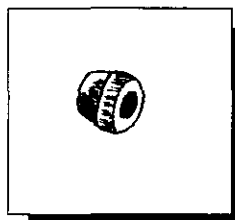

11.202

**BUSHING**, Front & Rear Shock  
 Absorber Mounting

4 Cyl : CJ, 1980-86 use J0637936  
 4 Cyl : Wr, 1987-89 use J3216638

6 Cyl : CJ, 1979-86 use J0637936  
 6 Cyl : Wr, 1987-89 use J3216638

8 Cyl : CJ, 1979-81 use J0637936

NOTE: 1. FOR THE FRONT SHOCK, TOP ONLY.

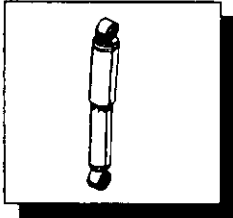

11.220

**SHOCK ASSY, Rear With Attaching Parts - STD**

4 Cyl : CJ, 1980 use J5353217  
 4 Cyl : CJ, 1981 use J8133294  
 4 Cyl : CJ, 1982-86 use J8133838<sup>2</sup>  
 4 Cyl : Wr, 1987-89 use 83502867

6 Cyl : CJ, 1979-80 use J5353217  
 6 Cyl : CJ, 1981 use J8133294  
 6 Cyl : CJ, 1982-86 use J8133838<sup>2</sup>  
 6 Cyl : Wr, 1987-89 use 83502867

8 Cyl : CJ, 1979-80 use J5353217  
 8 Cyl : CJ, 1981 use J8133294

**NOTE:**

1. IF STAMPED 5353217. IF STAMPED 5363751 USE J8133848.

2. FOR LIMITED OR SOFT RIDE MODEL, FOR CJ-7 ONLY, USE J8134105.

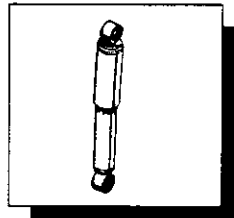

11.220

**SHOCK ASSY, Rear With Attaching Parts - Super Heavy Duty**

4 Cyl : CJ, 1980 use J5356433  
 4 Cyl : CJ, 1981 use J8133296  
 4 Cyl : CJ, 1982-86 use J8133840

6 Cyl : CJ, 1979-80 use J5356433  
 6 Cyl : CJ, 1981 use J8133296  
 6 Cyl : CJ, 1982-86 use J8133840

8 Cyl : CJ, 1979-80 use J5356433  
 8 Cyl : CJ, 1981 use J8133296

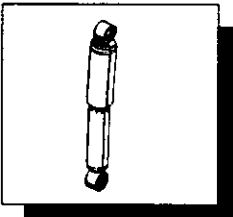

11.220

**SHOCK ASSY, Rear With Attaching Parts - Heavy**

4 Cyl : CJ, 1980 use J5361746  
 4 Cyl : CJ, 1981 use J8133295  
 4 Cyl : CJ, 1982-86 use J8133839  
 4 Cyl : Wr, 1987-89 use 83502837

6 Cyl : CJ, 1979 use J5355685  
 6 Cyl : CJ, 1980 use J5361746  
 6 Cyl : CJ, 1981 use J8133295  
 6 Cyl : CJ, 1982-86 use J8133839  
 6 Cyl : Wr, 1987-89 use 83502837

8 Cyl : CJ, 1979 use J5355685  
 8 Cyl : CJ, 1980 use J5361746  
 8 Cyl : CJ, 1981 use J8133295

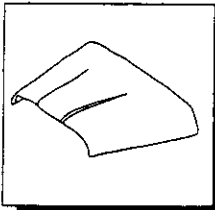

**12.001**

**HOOD ASSY**

4 Cyl : CJ, 1980-81 use J0986220  
 4 Cyl : CJ, 1982-86 use J5761180  
 4 Cyl : Wr, 1987-89 use 55013508

6 Cyl : CJ, 1979-81 use J0986220  
 6 Cyl : CJ, 1982-86 use J5761180  
 6 Cyl : Wr, 1987-89 use 55013508

8 Cyl : CJ, 1979-81 use J0986220

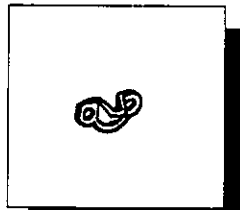

**12.060**

**BRACKET, Hood Catch - Chrome**

4 Cyl : CJ, 1980-84 use J5751190 1  
 4 Cyl : CJ, 1985-86 use J5766775

6 Cyl : CJ, 1979-84 use J5751190 1  
 6 Cyl : CJ, 1985-86 use J5766775

8 Cyl : CJ, 1979-81 use J5751190

NOTE: 1. COLOR WAS ORIGINALLY NEUTRAL GREY.

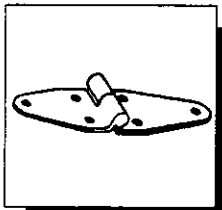

**12.035**

**HINGE, Hood - Left & Right**

4 Cyl : CJ, 1980-86 use J5459516  
 4 Cyl : Wr, 1987-89 use 55016588

6 Cyl : CJ, 1979-86 use J5459516  
 6 Cyl : Wr, 1987-89 use 55016588

8 Cyl : CJ, 1979-81 use J5459516

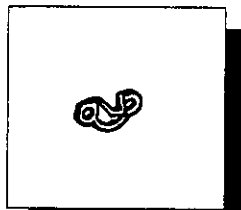

**12.060**

**BRACKET, Hood Catch - Black**

4 Cyl : CJ, 1980-86 use J0974111  
 4 Cyl : Wr, 1987-89 use 55009343

6 Cyl : CJ, 1979-86 use J0974111  
 6 Cyl : Wr, 1987-89 use 55009343

8 Cyl : CJ, 1979-81 use J0974111

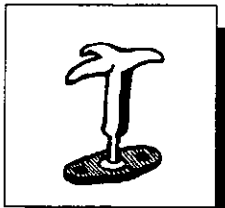

**12.060**

**CATCH, Hood Assy - Chrome**

4 Cyl : CJ, 1980-84 use J5751191 1  
 4 Cyl : CJ, 1985-86 use J5766762

6 Cyl : CJ, 1979-84 use J5751191 1  
 6 Cyl : CJ, 1985-86 use J5766762

8 Cyl : CJ, 1979-81 use J5751191 1

NOTE: 1. COLOR WAS ORIGINALLY NEUTRAL GREY.

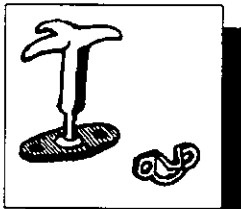

**HOOD CATCH KIT,  
 Catch & Bracket - Chrome**

4 Cyl : CJ, 1980-86 use HC-1

6 Cyl : CJ, 1979-86 use HC-1

8 Cyl : CJ, 1979-81 use HC-1

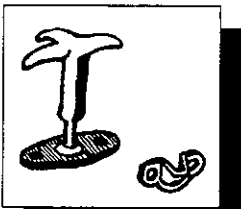

**HOOD CATCH KIT,  
 Catch & Bracket - Black**

4 Cyl : CJ, 1980-86 use HC-2

6 Cyl : CJ, 1979-86 use HC-2

8 Cyl : CJ, 1979-81 use HC-2

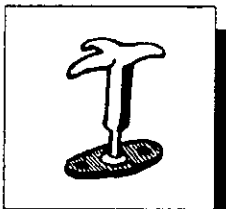

**12.060**

**CATCH, Hood Assy - Black**

4 Cyl : CJ, 1980-86 use J0977749  
 4 Cyl : Wr, 1987-89 use 55009428

6 Cyl : CJ, 1979-86 use J0977749  
 6 Cyl : Wr, 1987-89 use 55009428

8 Cyl : CJ, 1979-81 use J0977749

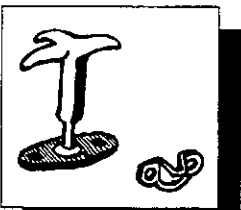

**HOOD CATCH KIT,  
 Catch & Bracket - Stainless Steel**

4 Cyl : CJ, 1980-86 use HC-3

6 Cyl : CJ, 1979-86 use HC-3

8 Cyl : CJ, 1979-81 use HC-3

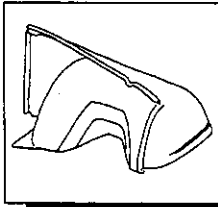

12.075

**FENDER ASSY,  
Left**

4 Cyl : CJ, 1980-82 use J5758965 1  
4 Cyl : CJ, 1983-86 use J5764629  
4 Cyl : Wr, 1987-89 use 55013515

6 Cyl : CJ, 1979-82 use J5758965 1  
6 Cyl : CJ, 1983-86 use J5764629  
6 Cyl : Wr, 1987-89 use 55013515

8 Cyl : CJ, 1979-81 use J5758965 1

**NOTE:** 1. WITHOUT HOLES FOR FENDER EXTENSION. THROUGH 1983. MODIFICATION TO SPLASH APRON IS REQUIRED ON MODELS PRIOR TO 1982.

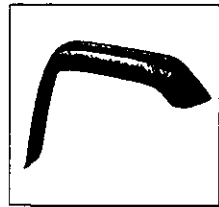

12.075

**FENDER EXTENSION,  
3" Width - Right Front**

4 Cyl : CJ, 1980-86 use J5455072 1  
4 Cyl : Wr, 1987-89 use 55050053 2

6 Cyl : CJ, 1979-86 use J5455072 1  
6 Cyl : Wr, 1987-89 use 55050053 2

8 Cyl : CJ, 1979-81 use J5455072

**NOTE:**

1. 1985-86, WITH 5" WIDTH USE J5762592.

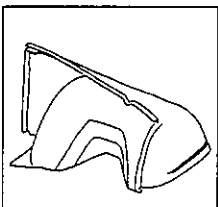

12.075

**FENDER ASSY,  
Right**

4 Cyl : CJ, 1980-82 use J5758964 1  
4 Cyl : CJ, 1983-86 use J5764630  
4 Cyl : Wr, 1987-89 use 55013514

6 Cyl : CJ, 1979-82 use J5758964 1  
6 Cyl : CJ, 1983-86 use J5764630  
6 Cyl : Wr, 1987-89 use 55013514

8 Cyl : CJ, 1979-81 use J5758964 1

**NOTE:** 1. WITHOUT HOLES FOR FENDER EXTENSION. THROUGH 1983. MODIFICATION TO SPLASH APRON IS REQUIRED ON MODELS PRIOR TO 1982.

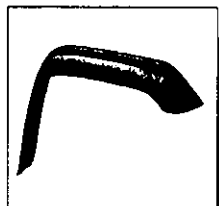

20.173

**FENDER EXTENSION,  
3" Width - Left Rear**

All CJ, 1979-86 use J5455073  
All Wr, 1987-89 use 55050055

**FENDER EXTENSION,  
3" Width - Right Rear**

All CJ, 1979-86 use J5455074  
All Wr, 1987-89 use 55050056

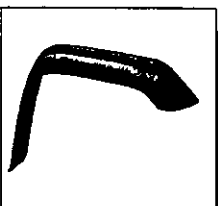

12.075

**FENDER EXTENSION,  
3" Width - Left Front**

4 Cyl : CJ, 1980-86 use J5455071 1  
4 Cyl : Wr, 1987-89 use 55050054 2

6 Cyl : CJ, 1979-86 use J5455071 1  
6 Cyl : Wr, 1987-89 use 55050054 2

8 Cyl : CJ, 1979-81 use J5455071

**NOTE:**

1. 1985-86, WITH 5" WIDTH USE J5762593.

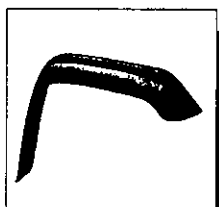

12.075

**FENDER EXTENSION KIT,  
Front & Rear Fenders, Including  
Mounting Hardware**

4 Cyl : CJ, 1980-86 use J8997109

6 Cyl : CJ, 1979-86 use J8997109

8 Cyl : CJ, 1979-81 use J8997109

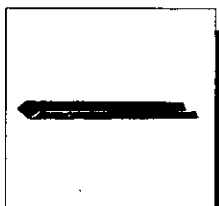

12.168

**RAIL, Front Bumper (Painted)**

4 Cyl : CJ, 1980-86 use J5355342  
4 Cyl : Wr, 1987-89 use 52040026 1

6 Cyl : CJ, 1979-86 use J5355342  
6 Cyl : Wr, 1987-89 use 52040026 1

8 Cyl : CJ, 1979-81 use J5355342

**NOTE:** 1. FOR CHROME USE 52040024.

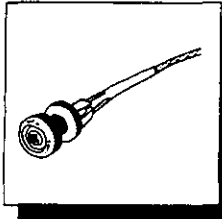

**13.017**

**CABLE, Heater & Defroster Control**

4 Cyl : CJ, 1980-82 use J5463655  
4 Cyl : Wr, 1987-89 use 56001473

6 Cyl : CJ, 1979-82 use J5463655  
6 Cyl : Wr, 1987-89 use 56001473

8 Cyl : CJ, 1979-80 use J5463655

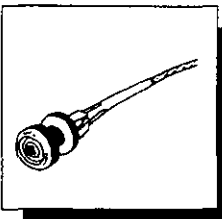

**13.017**

**CABLE, Temperature Control**

4 Cyl : CJ, 1980-86 use J5463656  
4 Cyl : Wr, 1987-89 use 56001472

6 Cyl : CJ, 1979-86 use J5463656  
6 Cyl : Wr, 1987-89 use 56001472

8 Cyl : CJ, 1979-81 use J5463656

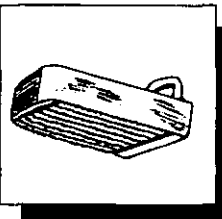

**13.028**

**CORE, Heater**

4 Cyl : CJ, 1980-86 use J5469877  
4 Cyl : Wr, 1987-89 use 56001459

6 Cyl : CJ, 1979-86 use J5469877  
6 Cyl : Wr, 1987-89 use 56001459

8 Cyl : CJ, 1979-81 use J5469877

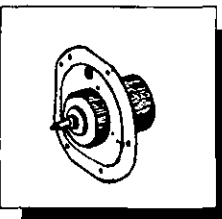

**13.072**

**MOTOR, Heater & Defroster**

4 Cyl : CJ, 1980-86 use J5751827  
4 Cyl : Wr, 1987-89 use 56001449

6 Cyl : CJ, 1979 use J5461581  
6 Cyl : CJ, 1980-86 use J5751827  
6 Cyl : Wr, 1987-89 use 56001449

8 Cyl : CJ, 1979 use J5461581  
8 Cyl : CJ, 1980-81 use J5751827



**15.270**

**MIRROR, Outside Rear View**  
CJ-7 Limited & YJ-Wrangler - **Left**

4 Cyl : CJ, 1982-86 use J8134189  
4 Cyl : Wr, 1987-89 use 55024249

6 Cyl : CJ, 1982-86 use J8134189  
6 Cyl : Wr, 1987-89 use 55024249

**NOTE:** 1. THIS MIRROR FOR HARDTOP. FOR CONVERTIBLE TOP USE 82200833. FOR LOW PROFILE MIRROR USE 55012573.

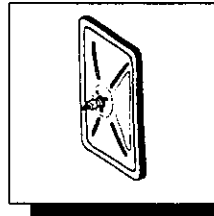

**15.270**

**MIRROR HEAD, Chrome**

6-3/4 x 6-3/4 - Without Arm & Bracket

4 Cyl : CJ, 1980-86 use J5751193

6 Cyl : CJ, 1979-86 use J5751193

8 Cyl : CJ, 1979-81 use J5751193

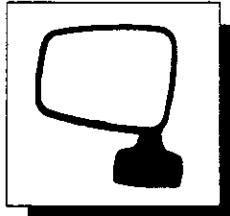

**15.270**

**MIRROR, Outside Rear View**  
CJ-7 Limited & YJ-Wrangler - **Right**

4 Cyl : CJ, 1982-86 use J8134188  
4 Cyl : Wr, 1987-89 use 55016210

6 Cyl : CJ, 1982-86 use J8134188  
6 Cyl : Wr, 1987-89 use 55016210

**NOTE:** 1. THIS MIRROR FOR USE WITH HARD DOORS. FOR 1/2 DOORS USE 82200834. FOR LOW PROFILE MIRROR USE 55012573.

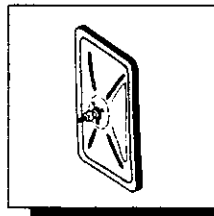

**15.270**

**MIRROR HEAD, Stainless Steel**

6-3/4 x 6-3/4 - Without Arm & Bracket

4 Cyl : CJ, 1980-86 use 5751193ST

6 Cyl : CJ, 1979-86 use 5751193ST

8 Cyl : CJ, 1979-81 use 5751193ST

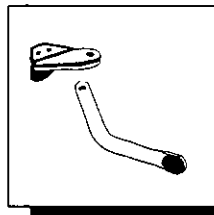

**15.270**

**ARM & BRACKET, Outside Rear View Mirror Mounting - Black - Left**

4 Cyl : CJ, 1980-86 use J5455301  
4 Cyl : Wr, 1987-89 use 55012575

6 Cyl : CJ, 1979-86 use J5455301  
6 Cyl : Wr, 1987-89 use 55012575

8 Cyl : CJ, 1979-81 use J5455301

**NOTE:** 1. FOR LOW PROFILE MIRROR ONLY.

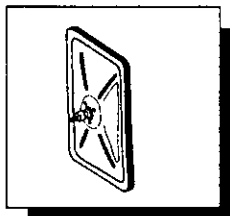

**15.270**

**MIRROR HEAD, Square - Black**  
6-3/4" x 6-3/4" - Without Arm & Bracket

4 Cyl : CJ, 1980-86 use J5462736

6 Cyl : CJ, 1979-86 use J5462736

8 Cyl : CJ, 1979-81 use J5462736

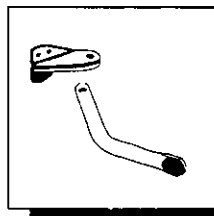

**15.270**

**ARM & BRACKET, Outside Rear View Mirror Mounting - Black - Right**

4 Cyl : CJ, 1980-86 use J5455302  
4 Cyl : Wr, 1987-89 use 55012574

6 Cyl : CJ, 1979-86 use J5455302  
6 Cyl : Wr, 1987-89 use 55012574

8 Cyl : CJ, 1979-81 use J54535302

**NOTE:** 1. FOR LOW PROFILE MIRROR ONLY.

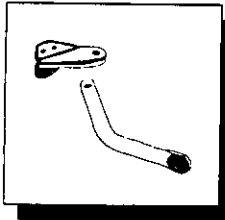

**15.270**

**ARM & BRACKET**, Outside Rear View Mirror Mounting - **Chrome** - Left

4 Cyl : CJ, 1980-86 use J5751194

6 Cyl : CJ, 1979-86 use J5751194

8 Cyl : CJ, 1979-81 use J5751194

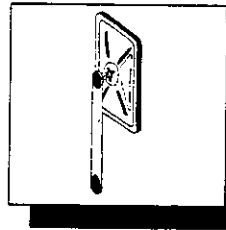

**MIRROR KIT**, Contains Mirror Head And Arm - **Black** - Left

4 Cyl : CJ, 1980-86 use 5455301K

6 Cyl : CJ, 1979-86 use 5455301K

8 Cyl : CJ, 1979-81 use 5455301K

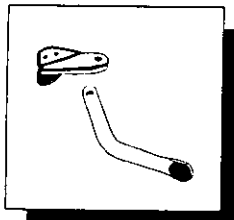

**15.270**

**ARM & BRACKET**, Outside Rear View Mirror Mounting - **Chrome** - Right

4 Cyl : CJ, 1980-86 use J5751195

6 Cyl : CJ, 1979-86 use J5751195

8 Cyl : CJ, 1979-81 use J5751195

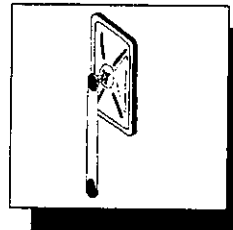

**MIRROR KIT**, Contains Mirror Head And Arm - **Black** - Right

4 Cyl : CJ, 1980-86 use 5455302K

6 Cyl : CJ, 1979-86 use 5455302K

8 Cyl : CJ, 1979-81 use 5455302K

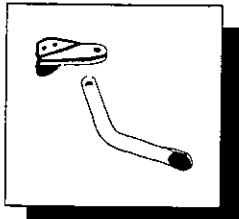

**15.270**

**ARM & BRACKET**, Outside Rear View Mirror Mounting - **Stainless Steel** Left

4 Cyl : CJ, 1980-86 use 5751194ST

6 Cyl : CJ, 1979-86 use 5751194ST

8 Cyl : CJ, 1979-81 use 5751194ST

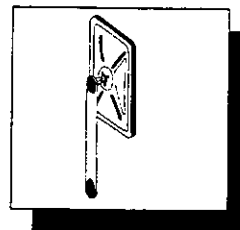

**MIRROR KIT**, Contains Mirror Head And Arms - **Chrome** - Left

4 Cyl : CJ, 1980-86 use 5751194K

6 Cyl : CJ, 1979-86 use 5751194K

8 Cyl : CJ, 1979-81 use 5751194K

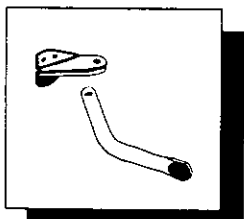

**15.270**

**ARM & BRACKET**, Outside Rear View Mirror Mounting - **Stainless Steel** Right

4 Cyl : CJ, 1980-86 use 5751195ST

6 Cyl : CJ, 1979-86 use 5751195ST

8 Cyl : CJ, 1979-81 use 5751195ST

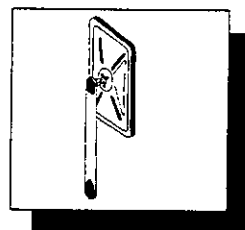

**MIRROR KIT**, Contains Mirror Head And Arms - **Chrome** - Right

4 Cyl : CJ, 1980-86 use 5751195K

6 Cyl : CJ, 1979-86 use 5751195K

8 Cyl : CJ, 1979-81 use 5751195K



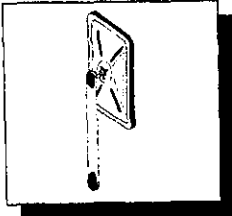

**MIRROR KIT**, Contains Mirror Head  
And Arm - **Stainless Steel** - Left

- 4 Cyl : CJ, 1980-86 use 5751194STK
- 6 Cyl : CJ, 1979-86 use 5751194STK
- 8 Cyl : CJ, 1979-81 use 5751194STK

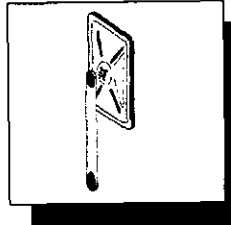

**MIRROR SET**, Contains 2 Mirrors,  
Left Arm and Right Arm - **Stainless**

- 4 Cyl : CJ, 1980-86 use 5751193STK
- 6 Cyl : CJ, 1979-86 use 5751193STK
- 8 Cyl : CJ, 1979-81 use 5751193STK

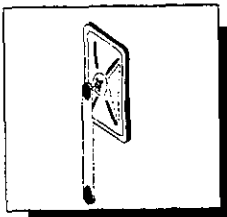

**MIRROR KIT**, Contains Mirror Head  
And Arm - **Stainless Steel** - Right

- 4 Cyl : CJ, 1980-86 use 5751195STK
- 6 Cyl : CJ, 1979-86 use 5751195STK
- 8 Cyl : CJ, 1979-81 use 5751195STK

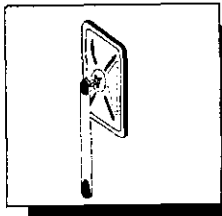

**MIRROR SET**, Contains 2 Mirrors,  
Left Arm and Right Arm - **Black**

- 4 Cyl : CJ, 1980-86 use 5462736K
- 6 Cyl : CJ, 1979-86 use 5462736K
- 8 Cyl : CJ, 1979-81 use 5462736K

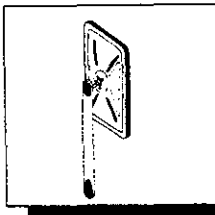

**MIRROR SET**, Contains 2 Mirrors,  
Left Arm and Right Arm - **Chrome**

- 4 Cyl : CJ, 1980-86 use 5751193K
- 6 Cyl : CJ, 1979-86 use 5751193K
- 8 Cyl : CJ, 1979-81 use 5751193K

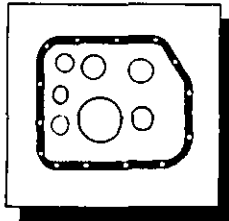

16.035

**GASKET & SEAL, Overhaul Kit**

4 Cyl : CJ, 1980-81 use J8130350  
 4 Cyl : Wr, 1987-89 use J8134681  
  
 6 Cyl : CJ, 1979-83 use J8130350  
 6 Cyl : CJ, 1984 use J8134681  
 6 Cyl : Wr, 1987-89 use J8134681  
  
 8 Cyl : CJ, 1979-81 use J8130350

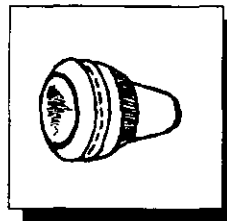

18.130

**KNOB, Transfer Case Shift Lever**

4 Cyl : CJ, 1980-81 use J5361403  
 4 Cyl : CJ, 1982-86 use J3241062  
 4 Cyl : Wr, 1987-89 use J3241062  
  
 6 Cyl : CJ, 1979 use J5355941  
 6 Cyl : CJ, 1980-81 use J5361403  
 6 Cyl : CJ, 1982-86 use J3241062  
 6 Cyl : Wr, 1987-89 use J3241062  
  
 8 Cyl : CJ, 1979 use J5355941  
 8 Cyl : CJ, 1980-81 use J5361403

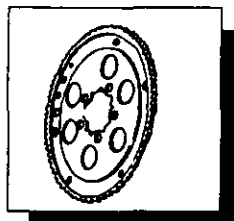

16.035

**PLATE, Converter Drive (Flex-Plate)**

4 Cyl : CJ, 1980-81 use J8132463  
 4 Cyl : Wr, 1987 use J3232138  
 4 Cyl : Wr, 1988-89 use 33004359  
  
 6 Cyl : CJ, 1979-84 use J3232138  
 6 Cyl : Wr, 1987 use J3232138  
 6 Cyl : Wr, 1988-89 use 33004359  
  
 8 Cyl : CJ, 1979-81 use J3232138

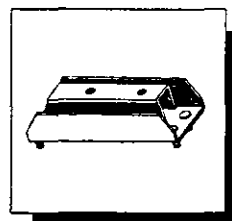

18.197

**INSULATOR, Transfer Case  
(Plate & Bracket)**

4 Cyl : CJ, 1980 use J1370910  
 4 Cyl : CJ, 1981-86 use J3238013  
  
 6 Cyl : CJ, 1979-86 use J1370910  
  
 8 Cyl : CJ, 1979-81 use J1370910

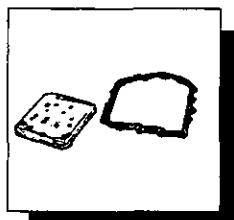

16.345

**FILTER KIT, Includes Gasket**

4 Cyl : CJ, 1980-81 use J8127652  
 4 Cyl : Wr, 1987-89 use J8127652  
  
 6 Cyl : CJ, 1979-84 use J8127652  
 6 Cyl : Wr, 1987-89 use J8127652  
  
 8 Cyl : CJ, 1979-81 use J8127652

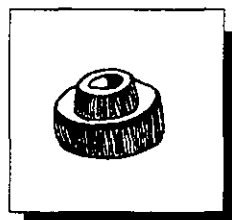

18.210

**INSULATOR, Transfer Case and  
Transmission Torque Reaction (Round)**

4 Cyl : CJ, 1980-86 use J0945266  
 4 Cyl : Wr, 1987-89 use J0945266  
  
 6 Cyl : CJ, 1979-86 use J0945266  
 6 Cyl : Wr, 1987-89 use J0945266  
  
 8 Cyl : CJ, 1979-81 use J0945266

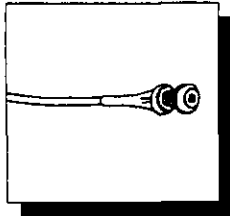

**22.020**

**CONTROL, Fresh Air Duct**

4 Cyl : CJ, 1980-86 use J5463657  
 4 Cyl : Wr, 1987-89 use 56001934  
 6 Cyl : CJ, 1979-86 use J5463657  
 6 Cyl : Wr, 1987-89 use 56001934  
 8 Cyl : CJ, 1979-81 use J5463657

NOTE: 1. LESS SPRING ATTACHMENT USE 56002698.

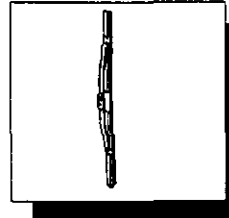

**22.043**

**BLADE, Windshield Wiper**

4 Cyl : CJ, 1980 use J0973819  
 4 Cyl : CJ, 1981-86 use J5758032  
 4 Cyl : Wr, 1987-89 use 55000299  
 6 Cyl : CJ, 1979-80 use J0973819  
 6 Cyl : CJ, 1981-86 use J5758032  
 6 Cyl : Wr, 1987-89 use 55000299

8 Cyl : CJ, 1979-80 use J0973819  
 8 Cyl : CJ, 1981 use J5758032

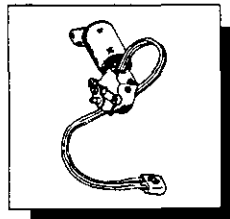

**22.027**

**MOTOR, Windshield Wiper**

4 Cyl : CJ, 1980-82 use J5453956  
 4 Cyl : CJ, 1983-86 use J5763696  
 4 Cyl : Wr, 1987-89 use 56030005  
 6 Cyl : CJ, 1979-82 use J5453956  
 6 Cyl : CJ, 1983-86 use J5763696  
 6 Cyl : Wr, 1987-89 use 56030005  
 8 Cyl : CJ, 1979-81 use J5453956

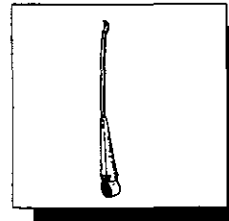

**22.044**

**ARM, Windshield Wiper**

4 Cyl : CJ, 1980 use J0979281  
 4 Cyl : CJ, 1981-86 use J5758005  
 4 Cyl : Wr, 1987-89 use 56030012  
 6 Cyl : CJ, 1979-80 use J0979281  
 6 Cyl : CJ, 1981-86 use J5758005  
 6 Cyl : Wr, 1987-89 use 56030012  
 8 Cyl : CJ, 1979-80 use J0979281  
 8 Cyl : CJ, 1981 use J5758005

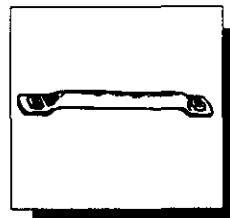

**22.035**

**LINK, Windshield Wiper Motor Drive**

4 Cyl : CJ, 1980-86 use J5453960  
 4 Cyl : Wr, 1987-89 use 56030011  
 6 Cyl : CJ, 1979-86 use J5453960  
 6 Cyl : Wr, 1987-89 use 56030011  
 8 Cyl : CJ, 1979-81 use J5453960

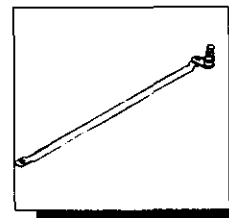

**22.047**

**PIVOT ASSY, Windshield Wiper Shaft (Less Rod)**

4 Cyl : CJ, 1980-86 use J5453957  
 6 Cyl : CJ, 1979-86 use J5453957  
 8 Cyl : CJ, 1979-81 use J5453957



**22.038**

**CONTROL, Windshield Wiper**

4 Cyl : CJ, 1980-82 use J5460089  
 4 Cyl : CJ, 1983-86 use J5758687  
 4 Cyl : Wr, 1987-89 use 56001864  
 6 Cyl : CJ, 1979-82 use J5460089  
 6 Cyl : CJ, 1983-86 use J5758687  
 6 Cyl : Wr, 1987-89 use 56001864  
 8 Cyl : CJ, 1979-80 use J5460089

NOTE:  
 1. WITH INTERMITTENT WIPER USE J5758904.

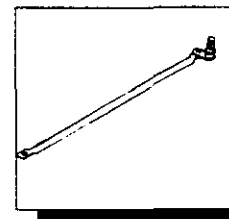

**22.047**

**PIVOT ASSY, Windshield Wiper Shaft (Including Rod)**

4 Cyl : CJ, 1980-86 use J5453958  
 4 Cyl : Wr, 1987-89 use 56030008  
 6 Cyl : CJ, 1979-86 use J5453958  
 6 Cyl : Wr, 1987-89 use 56030008  
 8 Cyl : CJ, 1979-81 use J5453958

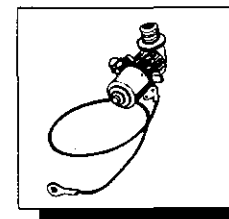

**22.051**

**PUMP, Windshield Washer (Two Speed)**

4 Cyl : CJ, 1980-86 use J8121404  
 4 Cyl : Wr, 1987-89 use 56002053  
 6 Cyl : CJ, 1979-86 use J8121404  
 6 Cyl : Wr, 1987-89 use 56002053  
 8 Cyl : CJ, 1979-81 use J8121404

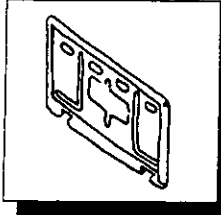

**23.006**

**TAILGATE**

4 Cyl : CJ, 1980-86 use J5454025  
4 Cyl : Wr, 1987-89 use 57001412

6 Cyl : CJ, 1979-86 use J5454025  
6 Cyl : Wr, 1987-89 use 57001412

8 Cyl : CJ, 1979-80 use J5454025

NOTE: 1. FOR CJ-5 USE J0685459.

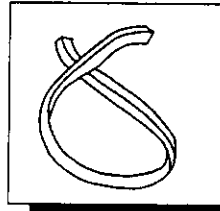

**25.002**

**WEATHERSTRIP, Windshield Frame to Cowl**

4 Cyl : CJ, 1980-86 use J5453950  
4 Cyl : Wr, 1987-89 use 55009127

6 Cyl : CJ, 1979-86 use J5453950  
6 Cyl : Wr, 1987-89 use 55009127

8 Cyl : CJ, 1979-81 use J5453950

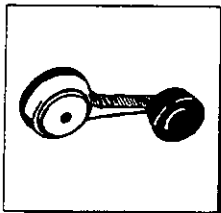

**23.100**

**HANDLE, Door Window Regulator (With Knob)**

4 Cyl : CJ, 1980-86 use J3678907  
4 Cyl : Wr, 1987-89 use J3678907

6 Cyl : CJ, 1979-86 use J3678907  
6 Cyl : Wr, 1987-89 use J3678907

8 Cyl : CJ, 1979-81 use J3678907

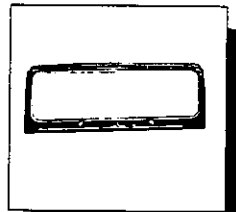

**25.003**

**FRAME, Windshield**

4 Cyl : CJ, 1980-86 use J5758971  
4 Cyl : Wr, 1987-89 use 55013509

6 Cyl : CJ, 1979-86 use J5758971  
6 Cyl : Wr, 1987-89 use 55013509

8 Cyl : CJ, 1979-81 use J5758971

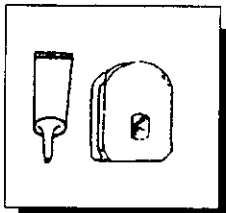

**25.002**

**KIT, Mirror Mounting Support - Inside Rear View**

4 Cyl : CJ, 1980-86 use J8120995  
4 Cyl : Wr, 1987-89 use J8120995

6 Cyl : CJ, 1979-86 use J8120995  
6 Cyl : Wr, 1987-89 use J8120995

8 Cyl : CJ, 1979-81 use J8120995

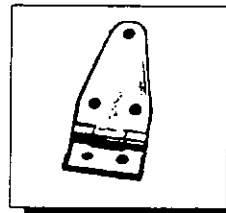

**25.005**

**HINGE, Windshield Frame - Left**

4 Cyl : CJ, 1980-86 use J5462425<sup>1</sup>  
4 Cyl : Wr, 1987-89 use 83502965<sup>2</sup>

6 Cyl : CJ, 1979-86 use J5462425<sup>1</sup>  
6 Cyl : Wr, 1987-89 use 83502965<sup>2</sup>

8 Cyl : CJ, 1979-81 use J5462425<sup>1</sup>

NOTE: 1. NOT USED WITH CJ-5 WITH METAL CAB.  
2. WITH HALF DOORS AND WINDSHIELD HINGE MOUNTED MIRROR USE 83502967.

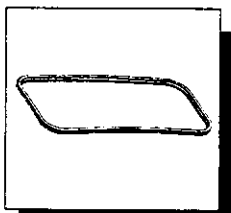

**25.002**

**CHANNEL, Windshield Glass Weatherstrip**

4 Cyl : CJ, 1980-86 use J5453949

6 Cyl : CJ, 1979-86 use J5453949

8 Cyl : CJ, 1979-81 use J5453949

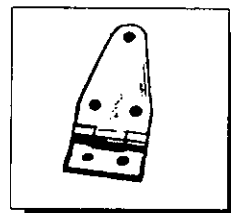

**25.005**

**HINGE, Windshield Frame - Right**

4 Cyl : CJ, 1980-86 use J5462424<sup>1</sup>  
4 Cyl : Wr, 1987-89 use 83502964<sup>2</sup>

6 Cyl : CJ, 1979-86 use J5462424<sup>1</sup>  
6 Cyl : Wr, 1987-89 use 83502964<sup>2</sup>

8 Cyl : CJ, 1979-81 use J5462424<sup>1</sup>

NOTE: 1. NOT USED WITH CJ-5 WITH METAL CAB.  
2. WITH HALF DOORS AND WINDSHIELD HINGE MOUNTED MIRROR USE 83502966.

**FENDER EXTENSION KIT**

Replaces Part No. 8997109

**OEM Type Fender Extension Kit for the CJ's. Kit includes 4 Fender Flares, all necessary hardware and an installation instruction sheet.**

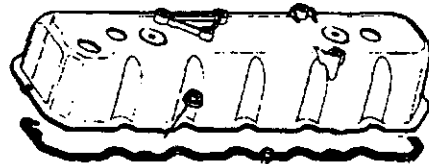
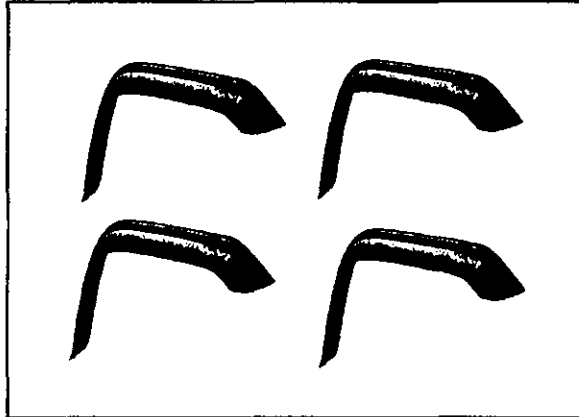

**ENGINE GROUP**

**NO DRILLING.** No special glue or time wasted during a "curing period"

**NO WONDERING,** "Will it work?"

**OUR NEW KIT** solves the problem **FAST**

<u>Part No.</u>	<u>Description</u>	<u>Application</u>
8983501398K	Valve Cover Kit	1981-Up 6-258

**INCLUDES:** Cover, Special gasket that seals and insulates at the same time, and hardware.

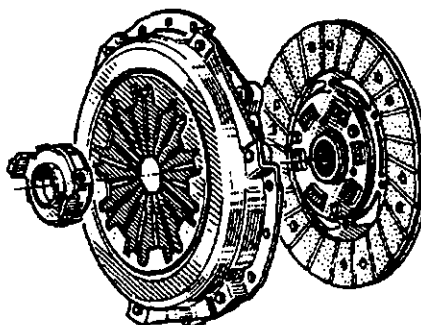
**CLUTCH GROUP**

**INCLUDES: Cover, Plate, and Bearing**

<b><u>Part No.</u></b>	<b><u>Description</u></b>	<b><u>Application</u></b>
930731K	<b>Clutch Kit</b>	Early CJ's 4 Cyl 8 1/2"
3184909K	<b>Clutch Kit</b>	1975-prior CJ5 1981-prior 'J' Series 10 1/2"
5360174K	<b>Clutch Kit</b>	CJ's 80-81 6 Cyl. V8-304 10 1/2"
3240278K	<b>Clutch Kit</b>	All 1982-up 6-258 10 1/2"
534689K	<b>Clutch Kit</b>	1976-79 CJ's with 3sp. trans. 10 1/2"
8132577K	<b>Clutch Kit</b>	1980-up with 4-151
53001420K	<b>Clutch Kit</b>	1983-85 4 Cyl. AMC Engine
53004538K	<b>Clutch Kit</b>	1987-88 XJ, Wrangler 2.5 4 Cyl.
53004116K	<b>Clutch Kit</b>	1987-88 XJ, Wrangler 4.0 6 Cyl.

## TRANSMISSION AND TRANSFER CASE GROUP

**INCLUDES:** All Snap Rngs, Washers, Needle Rollers, and Lock Plates

<u>Part No.</u>	<u>Description</u>	<u>Application</u>
T4-50	Small Parts Kit	T4 1981-Up 4 Speed
T5-50	Small Parts Kit	T5 1981-Up 5 Speed
SR4-50	Small Parts Kit	SR4 4 Speed
T150-50	Small Parts Kit	3 Speed T150 1976-79 CJ's
T170-50	Small Parts Kit	4 Speed T176, T177

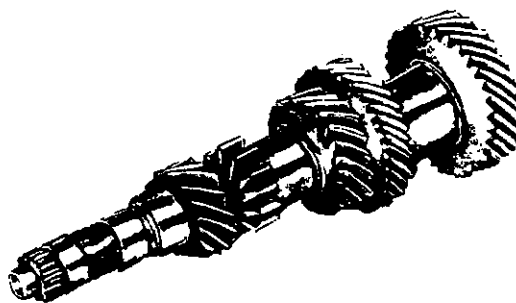
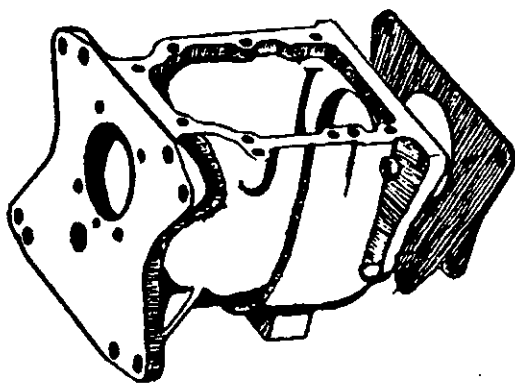

**INCLUDES:** All Gaskets and Seals

SR4-GS	Gasket Set	SR4 4 Speed
T170-GS	Gasket Set	4 Speed T176, T177
NP208-GS	Gasket Set	New Process Transfer Case 208
	<i>INCLUDES: All Gaskets and Seals</i>	
D300-GS	Gasket Set	Dana 300 Transfer Case
	<i>INCLUDES: All Gaskets, Shims, and Oil Seals</i>	
642188K	Intermediate Shaft Kit	Dana 18 with 1 1/8" Shaft
	<i>INCLUDES: Shaft, Bearings, Washers, and Snap Rings</i>	
942115K	Intermediate Shaft Kit	Dana 18 with 1 1/8 Shaft
	<i>INCLUDES: Shaft, Bearings, Washers, and Snap Rings</i>	
8122392K	Quadra Trac Chain and Gasket & Seal Set	

## AXLE GROUP

### AMC Rear Axle Model 20

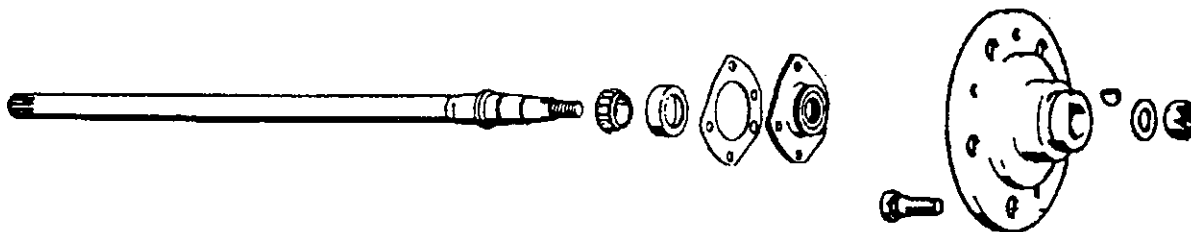

<u>Part No.</u>	<u>Description</u>	<u>Application</u>
8127070K (26 1/4")	<b>Rear Axle Kit</b> INCLUDES: Shaft, hub, seals, bearings, cups, nut, washer, and axle key.	CJ5 1976-83, CJ7 1976-81 (left side) L.Q.T.
8127071K (29 1/4")	<b>Rear Axle Kit</b> INCLUDES: Shaft, hub, seals, bearings, cups, nut, washer, and axle key.	CJ5 1976-83, CJ7 1976-81(right side)L.Q.T.
8133885K (28 1/4")	<b>Rear Axle Kit</b> INCLUDES: Shaft, hub, seals, bearings, cups, nut, washer, and axle key.	CJ7 & CJ8 1982-86 (left side) L.Q.T.
8133886K (31 1/2")	<b>Rear Axle Kit</b> INCLUDES: Shaft, hub, seals, bearings, cups, nut, washer, and axle key.	CJ7 & CJ8 1982-86 (right side) L.Q.T.
8127079K (33 1/2")	<b>Rear Axle Kit</b> INCLUDES: Shaft, hub, seals, bearings, cups, nut, washer, and axle key.	CJ5 & CJ7 1976-1979 (left side) with Q.T.
8127081K (22")	<b>Rear Axle Kit</b> INCLUDES: Shaft, hub, seals, bearings, cups, nut, washer, and axle key.	CJ5 & CJ7 1976-1979 (right side) with Q.T.
3155675K	<b>Rear Axle Nut Kit</b> INCLUDES: Nut, washer, and axle key.	All CJ's 1976-Up
3205533K	<b>Shim Kit</b> INCLUDES: All Pinion shim sizes	All CJ's 1976-Up
8133730K	<b>Rear Hub Kit</b> INCLUDES: Hub, seals, bearings, cups, nut, washer, and axle key.	All CJ's 1976-Up



**STEERING GROUP**

<u>Part No.</u>	<u>Description</u>	<u>Application</u>
8120221K	<b>Strg. Box Rep. Kit</b> <i>INCLUDES: Sector shaft seals, bushings, and bearings.</i>	Saginaw 72-Up Manual Steering
8134350K	<b>Tie Rod Assembly</b> <i>INCLUDES: Pitman arm to steering knuckle</i>	CJ7 1982-86

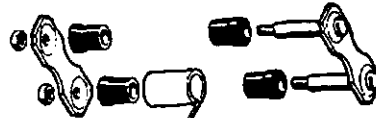

**SUSPENSION GROUP**

5357499K	<b>Shackle Kit</b> <i>INCLUDES: Bushings, plate, shackle, and self-locking nuts.</i>	CJ5, CJ7 1976-Up Rear Spring
5357620K	<b>Shackle Kit</b> <i>INCLUDES: Bushings, plate, shackle, and self-locking nuts.</i>	CJ5, CJ7, & CJ8 1976-Up Front Spring

**IGNITION GROUP**

<u>Part No.</u>	<u>Description</u>	<u>Application</u>
8120081K	<b>Ignition Switch Assy</b>	CJ's 1976-Up, 'J' Series and passenger cars.

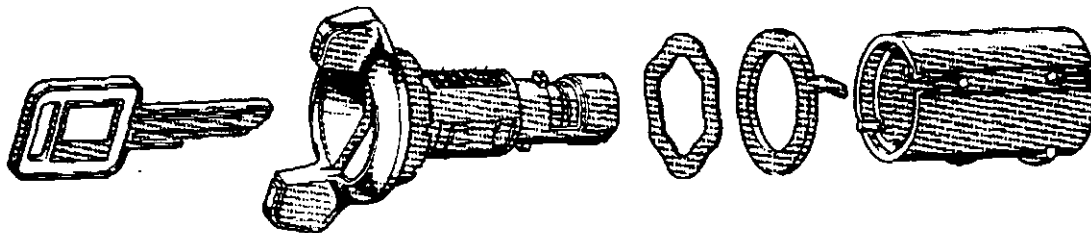

**ACCESSORIES**



<u>Part No.</u>	<u>Description</u>	<u>Application</u>
HC-1	<b>Hood Catch Kit (Chrome)</b> INCLUDES: Hood catch, bracket and screws.	All CJ's
HC-2	<b>Hood Catch Kit (Black)</b> INCLUDES: Hood catch, bracket and screws.	All CJ's
HC-3	<b>Hood Catch Kit (Stainless)</b> INCLUDES: Hood catch, bracket and screws	All CJ's
6V	<b>Wiper Motor Kit</b> INCLUDES: Motor, arm, and blade	Replaces vacuum type 6 volt
12V	<b>Wiper Motor Kit</b> INCLUDES: Motor, arm, and blade	Replaces vacuum type 12 volt
6V-ST	<b>Wiper Motor Kit (Stainless)</b> INCLUDES: Motor, arm, blade, and toggle switch.	Replaces vacuum type 12 volt
12V-ST	<b>Wiper Motor Kit (Stainless)</b> INCLUDES: Motor, arm, blade, and toggle switch.	Replaces vacuum type 12 volt

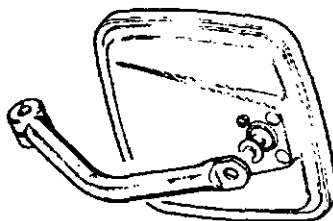

Mirror Kits Include: Mirror head and Arm.

5455301K	<b>Mirror Kit (black)</b>	All CJ's 1972-Up (left side)
5455302K	<b>Mirror Kit (black)</b>	All CJ's 1792-Up (right side)
5751194K	<b>Mirror Kit (chrome)</b>	All CJ's 1972-Up (left side)
5751195K	<b>Mirror Kit (chrome)</b>	All CJ's 1972-Up (right side)
5751194ST-K	<b>Mirror Kit (stainless)</b>	All CJ's 1972-Up (left side)
5751195ST-K	<b>Mirror Kit (stainless)</b>	All CJ's 1972-Up (right side)

# INDEX

**ACCELERATOR CABLE**, 22  
**ADJUSTER, CLUTCH WEAR** 29  
**AIR CLEANER DUCT TUBE (HOT AIR)**, 22  
**ALTERNATOR FAN**, 14, 15  
**ALTERNATOR PULLEY**, 15  
**ALTERNATOR**, 14  
**ARM & BRACKET (ARM AND BRACKET)**, 63, 64  
**ARM**  
    **STEERING LINKAGE PITMAN**, 52  
    **VALVE ROCKER**, 6  
    **WINDSHIELD WIPER**, 67  
**AXLE PINION YOKE (FRONT AXLE)**, 45

## **B**

**ROCKER ARM**, 6  
**THROWOUT LEVER (IN CLUTCH HOUSING)**, 27  
**BALL JOINT (STEERING KNUCKLE)**, 52  
**BEARING KIT**  
    **FRONT AXLE DIFFERENTIAL**, 47  
    **FRONT AXLE PINION**, 48  
    **STEERING SPINDLE**, 51  
**BEARING SET CAMSHAFT**, 2  
**BEARING**  
    **BRAKE PEDAL**, 34  
    **CLUTCH PEDAL**, 27  
    **CONNECTING ROD**, 8  
    **FRONT AXLE PINION**, 48  
    **FRONT WHEEL**, 36  
    **MAIN**, 1  
    **REAR AXLE DIFFERENTIAL**, 41, 42  
    **REAR AXLE PINION**, 42  
    **REAR WHEEL**, 37  
**BELLCRANK TO CLUTCH PEDAL SHAFT ROD**, 28  
**BELLCRANK, CLUTCH RELEASE IDLER**, 28  
**BELT SET, RADIATOR FAN**, 12  
**BELT**  
    **ALTERNATOR & CRANKSHAFT PULLEY**, 14  
    **CRANKSHAFT TO EXHAUST EMISSION PUMP**, 25  
    **P/S PUMP EXHAUST TO EMISSION AIR PUMP**, 26  
    **POWER STEERING PUMP**, 54  
    **RADIATOR FAN**, 11  
    **SERPENTINE DRIVE**, 11  
**BLADE, WINDSHIELD WIPER**, 67  
**BLADES, FAN (RADIATOR)**, 11  
**BLEEDER SCREW**, 39  
**BOLT**  
    **HOUSING RETAINER - DISC CALIPER**, 38  
    **PIVOT TO CYLINDER HEAD**, 6  
    **REAR AXLE WHEEL STUD**, 35  
    **VALVE ROCKER ARM BALL**, 6

**BOOT**  
    **BRAKE MASTER CYLINDER (W/O POWER)**, 33  
    **CLUTCH PIVOT - OUTER**, 28  
    **CLUTCH THROWOUT LEVER**, 27  
    **FLOOR GEAR SHIFT LEVER (MAN. TRANS)**, 30  
    **TRANS & TRANSFER SHIFT LEVER**, 30  
**BRACKET**  
    **FRONT SHOCK TO FRAME**, 58  
    **FRONT SUSPENSION SWAY STABILIZER**, 53  
    **HOOD CATCH**, 60  
**BRAKE MASTER CYLINDER**  
    **ASSY (W/O POWER)**, 33  
    **BOOT (W/O POWER)**, 33  
    **REPAIR KIT W/O POWER**, 33  
    **W/ POWER**, 37  
**BRAKE PEDAL**  
    **BEARING**, 34  
    **PAD RUBBER COVER W/MAN TRANS**, 35  
    **PAD RUBBER COVER W/AUTO TRANS**, 34  
**BRAKE SHOE**  
    **ADJUSTING SCREW - LEFT**, 32  
    **ADJUSTING SCREW NUT - LEFT**, 32  
    **ADJUSTING SCREW SOCKET**, 32  
    **ADJUSTING SCREW WASHER**, 32

**ANCHOR PIN GUIDE PLATE**, 33  
**BRAKE SHOE AUTO ADJUSTING**  
    **CABLE GUIDE**, 31  
    **LEVER**, 32  
    **LEVER SPRING**, 31  
    **LINK CABLE**, 31  
**BRAKE SHOE HOLD DOWN REAR SPRING**, 31  
**BRAKE SHOE HOLD DOWN SPRING PIN**, 31  
**BRAKE SHOE PARKING LEVER**, 33  
    **STRUT RETAINER**, 33  
    **STRUT WASHER**, 33  
**BRAKE SHOE RETURN SPRING**, 31  
**BRAKE TUBE FASTENING CLIP**, 34  
**BRIDGE, ROCKER ARM**, 6  
**BUMPER**  
    **FRONT**, 61  
    **FRONT AXLE**, 46  
    **REAR AXLE**, 43  
**BUSHING**  
    **CLUTCH RELEASE IDLER PIVOT**, 29  
    **CRANKSHAFT PILOT**, 2  
    **FRONT & REAR SHOCK ABSORBER MOUNTING**, 58  
    **FRONT SPRING**, 57  
    **LEAF SPRING SHACKLE**, 57  
    **REAR SPRING**, 57

## **C**

**ACCELERATOR**, 22  
**BRAKE SHOE AUTO ADJUSTING LINK**, 31  
**EQUALIZER TO REAR WHEELS**, 35  
**FOOT PARKING BRAKE LEVER - EQUALIZER**, 35  
**FRESH AIR DUCT CONTROL**, 67  
**FRONT FENDER SIDE LAMP**, 21  
**HEATER & DEFROSTER CONTROL**, 62  
**REAR SIDE MARKER LAMP**, 21  
**SPEEDOMETER (WITH CORE)**, 19  
**TEMPERATURE CONTROL**, 62  
**CALIPER ASSY, FRONT WHEEL DISC BRAKE**, 38  
**CAMSHAFT**, 2  
**CAMSHAFT BEARING SET**, 2  
**CAMSHAFT SPROCKET**, 8  
**CAP**  
    **DISTRIBUTOR**, 16  
    **FRONT WHEEL GREASE RETAINER**, 36  
    **NON-LOCKING FUEL TANK FILLER**, 23  
    **OIL FILTER**, 1  
    **RADIATOR CORE**, 12  
    **REAR WHEEL GREASE RETAINER**, 36  
    **TRANSMISSION CONTROL HOUSING**, 30  
**CARBURETOR**, 22  
**CARBURETOR REPAIR KITS**, 26  
**CASE ASSY, FRONT AXLE DIFFERENTIAL**, 46  
**CASE ASSY, REAR AXLE DIFFERENTIAL**, 40  
**CASE**  
    **FRONT AXLE DIFFERENTIAL**, 47  
    **REAR AXLE DIFFERENTIAL**, 40  
**CATCH, HOOD ASSY**, 60  
**CHAIN, TIMING**, 7  
**CHANNEL, WINDSHIELD GLASS WEATHERSTRIP**, 70  
**CLIP, BRAKE TUBE FASTENING**, 34  
**CLUTCH & BRAKE PEDAL SHAFT**, 28  
**CLUTCH**  
    **COVER ASSY**, 27  
    **DRIVEN PLATE**, 27  
    **CLUTCH KIT**, 70  
    **CLUTCH MASTER CYLINDER**  
        **ASSY**, 29  
        **REPAIR KIT**, 29  
    **CLUTCH PEDAL**  
        **BEARING**, 27  
        **PAD COVER**, 28  
        **SPRING**, 28  
    **CLUTCH PIVOT BOOT**, 28  
    **CLUTCH RELEASE IDLER**

# INDEX

- BELLCRANK, 28
- PIVOT BUSHING, 29
- PIVOT SUPPORT, 28
- CLUTCH SLAVE CYLINDER ASSY, 29
- REPAIR KIT, 29
- CLUTCH THROWOUT LEVER, 27
- BOOT, 27
- RETURN SPRING, 29
- SLEEVE (W/ BEARING), 27
- SPRING, 27
- CLUTCH WEAR ADJUSTER, 29
- COIL, IGNITION, 17
- COLD AIR INDUCTION DUCT, 22
- CONNECTING ROD ASSY, 8
- CONNECTING ROD BEARING, 8
- CONTROL
  - FRESH AIR DUCT, 8
  - WINDSHIELD WIPER, 67
- CONVERTER DRIVE PLATE, 66
- CORE, HEATER, 62
- COVER ASSY
  - CLUTCH, 27
  - TIMING CASE, 7
- COVER
  - BRAKE PEDAL PAD RUBBER, 34, 35
  - CLUTCH PEDAL PAD, 28
  - CYLINDER HEAD, 4
  - FLOOR GEAR SHIFT LEVER, 30
  - FRONT AXLE HOUSING, 46
- CRANKSHAFT SPROCKET, 8
- CUP
  - FRONT AXLE PINION BEARING, 48
  - FRONT WHEEL BEARING, 36
  - REAR AXLE PINION BEARING, 42
  - REAR WHEEL BEARING, 37
- CUSHION, FRONT SUSPENSION SWAY STABILIZER, 53
- CYLINDER ASSY
  - BRAKE MASTER (W/O POWER), 33
  - BRAKE WHEEL REAR, 34
  - CLUTCH MASTER, 29
  - POWER BRAKES MASTER, 37
- CYLINDER BLOCK PLUG, 1
- CYLINDER HEAD
  - COVER, 4
  - COVER GASKET, 4
  - HEAD GASKET, 3
- CYLINDER, IGNITION SWITCH, 17
- D**AMPER, EXHAUST MANIFOLD, 3
- D**AMPER, STEERING, 53
- D**IRECTIONAL SIGNAL FLASHER, 19
- D**ISC ASSY, FRONT WHEEL DISC BRAKE, 38
- D**ISC BRAKE, 38
- D**ISC BRAKE PISTON
  - REPAIR KIT, 39
  - REPAIR KIT W/PISTON, 39
- D**ISC KIT, REAR AXLE DIFFERENTIAL, 41
- D**ISTRIBUTOR, 16
  - CAP, 16
  - ROTOR, 16
  - VACUUM SOLENOID, 17
- D**OOR, HEADLAMP, 18
- D**RAINCOCK, RADIATOR CORE, 12
- D**RUM, REAR BRAKE (W/O HUB), 35
- D**UCT, COLD AIR INDUCTION, 22
- E**LEMENT
  - CARBURETOR AIR CLEANER, 22
  - OIL FILTER, 10
  - BREATHER, 6
  - ENGINE BEARING, 1
  - ENGINE OIL PAN
    - GASKET SET, 10
    - TO BEARING GAP SEAL, 10
  - ENGINE OIL PUMP ASSY, 10
  - ENGINE OIL PUMP COVER GASKET, 10
  - ENGINE OVERHAUL GASKET SET, 2
  - ENGINE RING SET, 9
  - ENGINE VALVE GRIND GASKET SET, 2
  - EQUALIZER, PARKING BRAKE CABLE, 35
- E**XHAUST
  - EMISSION BACKFIRE VALVE, 25
  - MANIFOLD SEAL, 25
  - PIPE, 24, 25
  - RECIRCULATING VALVE AND SENSOR GASKET, 26
- E**XHAUST MANIFOLD, 3
  - DAMPER, 3
  - DAMPER GASKET, 3
  - TO CYLINDER HEAD GASKET, 3
- E**XHAUST VALVE, 5
- E**XHAUST VALVE SEAL (DEFLECTOR) - STD, 5
- F**AN BELT (RADIATOR), 11
- F**AN BELT SET (RADIATOR), 11
- F**AN BLADES (RADIATOR), 11
- F**AN DRIVE CLUTCH TEMPATROL, 11
- F**AN ALTERNATOR, 14, 15
- F**ENDER ASSY, 61
- F**ENDER EXTENSION, 61
- F**ENDER EXTENSION KIT, 61,69
- F**ILTER KIT, FUEL PUMP (IN LINE), 23
- F**ILTER KIT (TRANSMISSION) , INCLUDES GASKET, 66
- F**ILTER
  - AIR, 22
  - CYLINDER HEAD COVER TO AIR CLEANER BREATHER, 6
- F**UEL TANK, 23
- F**UEL VAPOR STORAGE CANISTER, 24
- G**ASOLINE (IN-LINE), 23
- F**LANGE, FRONT AXLE SHAFT, 50
- F**LASHER
  - DIRECTIONAL SIGNAL, 19
  - HAZARD WARNING, 21
- F**OOT PARKING BRAKE LEVER CABLE - EQUALIZER, 35
- F**RAME, WINDSHIELD, 70
- F**RESH AIR DUCT CONTROL, 67
- F**RONT & REAR SHACKLE PLATE, 58
- F**RT SHOCK ABSORBER MOUNTING BUSHING, 58
- F**RONT & REAR SPRING U-BOLT, 56
- F**RONT AXLE
  - BUMPER, 46
  - DIFFERENTIAL GEAR SET, 47
  - DIFFERENTIAL BEARING KIT, 47
  - DIFFERENTIAL CASE, 47
  - DIFFERENTIAL CASE ASSY, 46
  - DIFFERENTIAL SHIM SET, 47
  - DRIVE PINION SHIM SET, 49
  - GEAR SET, 47, 48
  - HOUSING COVER, 46
  - HOUSING COVER GASKET, 46
  - PINION BEARING, 48
  - PINION BEARING CUP, 48
  - PINION BEARING KIT, 48
  - PINION BEARING OIL SEAL, 49
  - PINION BEARING OIL SLINGER, 49
  - PINION NUT, 48
  - PINION SHIM SET, 48
  - SHAFT ASSY, 49
  - SHAFT FLANGE, 50
  - SHAFT FLANGE GASKET, 50
  - SHAFT INNER OIL SEAL, 49
  - SHAFT SNAP RING, 49
  - SHAFT SPIDER ASSY, 50
  - HUB ASSY (W/ BOLTS), 35
- F**RONT BUMPER RAIL, 61
- F**RONT FENDER SIDE LAMP CABLE, 21

# INDEX

- MARKER LAMP, 21
- FRONT LEAF SPRING**
- ASSY, 55
- SHACKLE, 57
- TO AXLE PLATE, 56
- FRONT PROPELLER SHAFT**
- ASSY, 44
- YOKE KIT, 46
- UNIV JOINT SLEEVE YOKE, 45
- YOKE, 46
- FRONT SHOCK ASSY (W/ ATTACHING PARTS), 58**
- FRONT SPRING BUSHING, 57**
- FRONT STEERING SPINDLE OIL SEAL, 51**
- FRONT SUSPENSION SWAY STABILIZER**
- BRACKET, 53
- CUSHION, 53
- LINK, 53
- FRONT WHEEL BEARING, 36**
- CUP - INNER, 36
- LOCK WASHER, 36
- NUT LOCK WASHER, 37
- RETAINING NUT IN & OUT, 37
- FRONT WHEEL DISC BRAKE**
- ASSY STUD, 38
- CALIPER ASSY, 38
- DISC ASSY, 38
- HOSE, 39
- SHOE SET, 38
- FRONT WHEEL GREASE RETAINER, 36**
- FRONT WHEEL GREASE RETAINER CAP, 36**
- FUEL GAUGE, 20**
- FUEL PUMP 23**
- FILTER KIT (IN LINE), 23
- GASKET, 23
- FUEL TANK**
- FILTER, 23
- SENDING UNIT, 20
- STRAP (CENTER), 23
- ASSEMBLY - 15 GALLON, 23
- FUEL VAPOR STORAGE CANISTER FILTER, 24**
- FUSES, 17**
- GASKET & SEAL, OVERHAUL KIT (AUTOMATIC TRANSMISSION), 66**
- GASKET SET**
- ENGINE LOWER, 2
- ENGINE OIL PAN, 10
- ENGINE VALVE GRIND, 2
- ENGINE OVERHAUL, 2
- TIMING CASE COVER, 7
- GASKET**
- CYLINDER HEAD, 3
- CYLINDER HEAD COVER, 4
- ENGINE OIL PUMP COVER, 10
- EXHAUST MANIFOLD DAMPER, 3
- EXHAUST MANIFOLD TO CYLINDER HEAD, 3
- FRONT AXLE HOUSING COVER, 46
- FRONT AXLE SHAFT FLANGE, 50
- FUEL PUMP, 23
- FUEL TANK, 20
- INTAKE MANIFOLD TO CYLINDER HEAD, 3
- INTAKE MANIFOLD TO EXHAUST MANIFOLD, 3
- REAR AXLE HOUSING COVER, 40
- THERMOSTAT HOUSING, 13
- TIMING CASE COVER, 7
- WATER PUMP, 13
- EXHAUST RECIRCULATING VALVE & SENSOR, 26
- GASOLINE FILTER (IN-LINE), 23**
- GAUGE**
- FUEL, 20
- OIL PRESSURE, 20
- WATER TEMPERATURE, 20
- GEAR ASSY, STEERING, 53, 54**
- GEAR SET**
- FRONT AXLE RING AND PINION, 47, 48
- FRONT AXLE DIFFERENTIAL, 47
- REAR AXLE DIFFERENTIAL, 40
- REAR AXLE DIFFERENTIAL, 41
- REAR AXLE RING & PINION, 41, 42
- GEAR, FLYWHEEL RING, 2
- GRILLE, RADIATOR, 13
- GROMMET, CYLINDER HEAD COVER, 7
- GUIDE, BRAKE SHOE AUTO ADJUSTING CABLE, 31
- HANDLE, DOOR WINDOW REGULATOR, 68**
- HAZARD WARNING FLASHER, 21**
- HAZARD WARNING KNOB, 21**
- HEADLAMP DOOR, 18**
- HEADLAMP RETAINING RING, 18**
- HEADLIGHT DIMMER SWITCH, 18**
- HEAT RISER VALVE (DAMPER), 3**
- HEATER & DEFROSTER CONTROL CABLE, 62**
- HEATER & DEFROSTER MOTOR, 62**
- HEATER CORE, 62**
- HINGE, HOOD, 60**
- HINGE, WINDSHIELD FRAME, 68**
- HOOD ASSY, 60**
- HOOD**
- CATCH, 60
- CATCH BRACKET, 60
- CATCH KIT, 60, 74
- HINGE, 60
- HORN RELAY, 17**
- HORN, SINGLE, 17**
- HOSE**
- FRONT WHEEL DISC BRAKES, 39
- RADIATOR INLET, 12
- RADIATOR OUTLET, 13
- POWER STEERING PUMP, 54
- REAR BRAKE TUBE, 34
- WATER PUMP TO THERMOSTAT HOUSING, 13
- HOUSING RETAINER - DISC CALIPER BOLT, 38**
- HOUSING, THERMOSTAT, 13**
- HUB ASSY, BRAKE (W/ BOLTS), 35**
- HYDRAULIC CLUTCH TUBE, 29**
- IGNITION COIL, 17**
- IGNITION SWITCH, 17**
- IGNITION SWITCH ASSY, 73**
- IGNITION WIRE SET, 18**
- INSULATOR**
- FRONT ENGINE MOUNT, 1
- MUFFLER & TAILPIPE SIDE SUPPORT, 25
- TAILPIPE SUPPORT-REAR, 25
- TRANSFER CASE, 66
- INTAKE MANIFOLD TO CYL. HEAD GASKET, 3**
- INTAKE MANIFOLD TO EXHAUST MANIFOLD GASKET, 3**
- INTAKE VALVE, 4**
- INTAKE VALVE SEAL (DEFLECTOR) - STD, 4**
- Kits**
- CLUTCH, 70
- FENDER EXTENSION, 69
- GASKET SET, 71
- HOOD CATCH, 74
- INTERMEDIATE SHAFT, 71
- IGNITION SWITCH ASSY, 73
- MIRROR, 74
- QUADRA TRAC CHAIN AND GASKET & SEAL, 71
- REAR AXLE, 72
- REAR HUB, 72
- SHACKLE, 73
- SHIM, 72
- SMALL PARTS, 71
- STEERING BOX REPAIR KIT, 73
- TIE ROD ASSY, 73
- VALVE COVER, 69
- WIPER MOTOR, 74

# INDEX

**KNOB, HAZARD WARNING, 21, 3**  
**KNOB, TRANSFER CASE SHIFT LEVER, 66**  
**KNUCKLE, STEERING, 51**

## LAMP

**FRONT FENDER SIDE MARKER, 21**  
**PARKING & FRONT DIRECTIONAL SIGNAL, 18**  
**REAR FENDER SIDE MARKER, 21**  
**TAIL, STOP, AND REAR DIRECTIONAL, 18**  
**LEAF SPRINGS, 55, 56**  
**LEAF SPRING SHACKLE BUSHING, 57**  
**LENS, PARKING AND FRONT DIRECTIONAL SIGNAL, 18**  
**LENS, TAIL & STOP LAMP, 19**  
**LEVER**  
**BRAKE SHOE AUTO ADJUSTING, 32**  
**BRAKE SHOE PARKING, 33**  
**CLUTCH THROWOUT, 27**  
**FLOOR GEAR SHIFT, 30**  
**LIGHTING SWITCH, 17**  
**LINK, FRONT SUSPENSION SWAY STABILIZER, 53**  
**LINK, WINDSHIELD WIPER MOTOR DRIVE, 67**  
**LOCK, FUEL TANK GAUGE, 20**  
**LOCK, VALVE SPRING RETAINER (KEEPER), 5**

## MANIFOLD, EXHAUST, 3

### MASTER CYLINDER ASSY.

**BRAKE, W/O POWER, 33**  
**BRAKE W/ POWER, 37**  
**CLUTCH, 29**

### MIRROR, ARM AND BRACKET, 63,64

### MIRROR HEAD, 63

### MIRROR KIT, 64, 65

### MIRROR MOUNTING SUPPORT KIT, 65

### MIRROR SET, 65

### MIRROR, OUTSIDE REAR VIEW, 63

### MODULE, SOLID STATE IGNITION, 16

### MOTOR, WINDSHIELD WIPER, 67

### MOTOR MOUNT, 1

**REAR, (TRANSFER CASE INSULATOR), 66**

### MOTOR, HEATER & DEFROSTER, 62

### MOTOR, STARTING, 15

### MUFFLER, W/ TAILPIPE, 25

## NUT

**BRAKE SHOE ADJUSTING SCREW, 32**  
**FRONT AXLE PINION, 48**  
**FRONT WHEEL BEARING RETAINING IN & OUT, 37**

## OIL CAP, 1

### OIL FILTER ELEMENT, 10

### OIL PRESSURE

**GAUGE, 20**  
**SENDING UNIT, 20**

### OIL SEAL

**FRONT AXLE PINION BEARING, 49**

**FRONT AXLE SHAFT INNER, 49**

**FRONT STEERING SPINDLE, 51**

**REAR AXLE PINION BEARING, 42**

**REAR AXLE SHAFT, 43**

**OVERHAUL GASKET & SEAL KIT(AUTOMATIC TRANSMISSION), 66**

## PAD SET, DISC BRAKE, 38

**PARKING & FRT DIRECTIONAL SIGNAL LAMP, 18**

**PARKING BRAKE CABLE EQUALIZER, 35**

**PARKING BRAKE LEVER STRUT SPRING, 31**

**PCV VALVE, 7**

**PIN, BRAKE SHOE HOLD DOWN SPRING, 31**

**PIPE, EXHAUST, 24, 25**

**PISTON RING SET, 9**

**PISTON RINGS (SINGLE PISTON), 9**

### PISTON

**ENGINE, WITH PIN, 9**

**POWER BRAKE MASTER CYLINDER SECOND, 38**

**PITMAN ARM - STEERING ARM TIE ROD END ASSY, 53**

**PIVOT ASSY, WINDSHIELD WIPER SHAFT, 67**

**PIVOT TO CYLINDER HEAD BOLT, 6**

**PIVOT, VALVE ROCKER ARM, 6**

### PLATE

**BRAKE SHOE ANCHOR PIN GUIDE, 33**

**CLUTCH DRIVEN DISC, 27**

**CONVERTER DRIVE, 66**

**FRONT LEAF SPRING TO AXLE, 56**

**PRESSURE (CLUTCH), 27**

**REAR LEAF SPRING TO AXLE U-BOLT TIE, 57**

**PLUG, CYLINDER BLOCK CORE HOLE, 1**

**POWER BRAKE MASTER CYLINDER**

**PISTON SECOND, 38**

**REPAIR KIT, 38**

**ASSY, 37**

### POWER STEERING PUMP

**BELT, 54**

**HOSE, 54**

### PROPELLER SHAFTS, 44

**PROPELLER SHAFT SPIDER ASSY, 46**

**PULLEY, ALTERNATOR, 15**

### PUMP ASSY

**ENGINE OIL, 10**

**FUEL, 23**

**WATER (COOLANT), 13**

**WINDSHIELD WASHER, 67**

## RADIATOR

**CAP, 12**

**CORE, 12**

**DRAINCOCK, 12**

**FAN BELT, 11**

**FAN BELT SET, 12**

**FAN BLADES, 11**

**GRILLE, 13**

**RAIL, FRONT BUMPER, 61**

**REAR AXLE KIT, 72**

### REAR AXLE

**BUMPER, 43**

**DIFFERENTIAL CASE ASSY, 40**

**DIFFERENTIAL DISC KIT, 41**

**DIFFERENTIAL GEAR SET, 40, 41**

**DRIVE PINION SHIM SET, 42**

**HOUSING COVER GASKET, 40**

**PINION BEARING (INNER CONE), 42**

**PINION BEARING (OUTER CONE), 42**

**PINION BEARING CUP (INNER), 42**

**PINION BEARING CUP (OUTER), 42**

**PINION BEARING OIL SEAL, 42**

**PINION SPACER, 42**

**SHAFT, 43**

**SHAFT OIL SEAL, 43**

**WHEEL STUD BOLT, 35**

### REAR BRAKE

**DRUM, 35**

**HUB ASSY (W/ BOLTS), 35**

**SHOE SET, 31**

**TUBE HOSE, 34**

**WHEEL CYLINDER BLEEDER SCREW, 34**

**WHEEL CYLINDER REPAIR KIT, 34**

**WHEEL CYLINDER, 34**

**REAR HUB KIT, 72**

**REAR LEAF SPRING ASSY, 56**

### REAR WHEEL

**BEARING CUP, 37**

**BEARING RETAINER, 37**

**BEARING RING, 37**

**GREASE RETAINER CAP, 36**

**OIL SEAL, 37**

**RELAY, HORN, 17**

**RELAY, STARTING MOTOR (SOLENOID), 15**

### REPAIR KIT

**BRAKE MASTER CYLINDER W/O POWER, 33**

# INDEX

- CARBURETOR, 26
- CLUTCH MASTER CYLINDER, 29
- CLUTCH SLAVE CYLINDER, 29
- DISC BRAKE PISTON HOUSING, 39
- DISC BRAKE PISTON HOUSING W/PISTON, 39
- POWER BRAKE MASTER CYLINDER, 38
- REAR BRAKE WHEEL CYLINDER, 34
- RETAINER**
  - BRAKE SHOE PARKING LEVER STRUT, 33
  - FLOOR GEAR SHIFT LEVER, 30
  - FRONT WHEEL GREASE, 36
  - REAR WHEEL BEARING, 37
- RING SET, PISTON (ENGINE), 9**
- RING, HEADLAMP RETAINING, 18**
- RING, REAR WHEEL BEARING, 37**
- RINGS, PISTON (SINGLE PISTON), 9**
- ROCKER ARM, 6**
- ROCKER ARM BALL, 6**
- ROCKER ARM BRIDGE, 6**
- ROD ASSY**
  - CLUTCH FORK RELEASE, 29
  - CONNECTING, 8
  - STEERING ARM TO STEERING ARM TIE, 52
- ROD, BELLCRANK TO CLUTCH PEDAL SHAFT, 28**
- ROD, VALVE PUSH, 6**
- ROTOR, DISTRIBUTOR, 16**
- Screw**
  - BRAKE SHOE ADJUSTING, 32
  - BRAKE WHEEL CYLINDER BLEEDER, 39
  - REAR BRAKE WHEEL CYLINDER BLEEDER, 34
- SEAL KIT, REAR MAIN BEARING CAP, 1**
- DISC BRAKE PISTON, 39**
- SEAL**
  - ENGINE OIL PAN TO BEARING CAP, 10
  - EXHAUST PIPE TO MANIFOLD, 25
  - EXHAUST VALVE (DEFLECTOR) - STD, 5
  - FRONT SPINDLE BEARING, 51
  - INTAKE VALVE (DEFLECTOR) - STD, 4
  - OIL PAN TIMING CASE COVER, 10
  - REAR WHEEL OIL, 37
  - TIMING CASE COVER, 7
- SENDING UNIT**
  - FUEL TANK, 20
  - OIL PRESSURE, 20
  - WATER TEMPERATURE, 20
- SERPENTINE DRIVE BELT, 11**
- SHACKLE PLATE, FRONT & REAR, 58**
- SHACKLE, FRONT LEAF SPRING, 57**
- SHACKLE, REAR LEAF SPRING, 57**
- SHAFT ASSY, FRONT AXLE, 49, 73**
- SHAFT, CLUTCH & BRAKE PEDAL, 28**
- SHAFT, REAR AXLE, 43**
- SHIFT LEVER, 30**
  - BOOT, 30
  - COVER, 30
  - RETAINER, 30
  - SPRING, 30
- SHIM KIT, 72**
- SHIM SET**
  - FRONT AXLE DIFFERENTIAL, 47
  - FRONT AXLE DRIVE PINION, 49
  - FRONT AXLE PINION, 48
  - REAR AXLE DRIVE PINION, 42
- SHOCK ASSY, FRONT (W/ ATTACHING PARTS), 58**
- SHOCK ASSY, REAR (W/ ATTACHING PARTS), 59**
- SHOE SET, FRONT WHEEL DISC BRAKE, 38**
- SHOE SET, REAR BRAKE, 31**
- SLAVE CYLINDER ASSY, CLUTCH, 29**
- SLEEVE, CLUTCH THROWOUT LEVER (W/ BEARING), 27**
- SLINGER, FRONT AXLE PINION BEARING OIL, 49**
- SNAP RING, FRONT AXLE SHAFT, 49**
- SOCKET, BRAKE SHOE ADJUSTING SCREW, 32**
- SOLENOID**
  - DISTRIBUTOR VACUUM, 17
  - STARTER, 15
- SPACER, FRONT STEERING SPINDLE, 51**
- SPACER, REAR AXLE PINION, 42**
- SPEEDOMETER CABLE (WITH CORE), 19**
- SPEEDOMETER, 19**
- SPIDER ASSY, FRONT AXLE SHAFT, 50**
- SPIDER ASSY, PROPELLER SHAFT, 46**
- SPINDLE ASSY, STEERING, 51**
- SPRING ASSY, FRONT LEAF, 55**
- SPRING ASSY, REAR LEAF, 56**
- SPRING**
  - BRAKE SHOE AUTO ADJUSTING LEVER, 31
  - BRAKE SHOE RETURN - UPPER, 31
  - CLUTCH THROWOUT LEVER, 27
  - CLUTCH THROWOUT LEVER RETURN, 29
  - CLUTCH PEDAL, 28
  - FLOOR GEAR SHIFT LEVER, 30
  - PARKING BRAKE LEVER STRUT, 31
  - SHOE HOLD DOWN REAR, 31
  - VALVE, 5
- SPROCKET, CAMSHAFT, 8**
- SPROCKET, CRANKSHAFT, 8**
- STARTING MOTOR, 15**
- STARTING MOTOR RELAY (SOLENOID), 15**
- STEERING ARM**
  - TO STEERING ARM TIE ROD ASSY, 52
  - TO STEERING ARM TIE ROD END ASSY, 52
- STEERING**
  - DAMPER, 53
  - GEAR ASSY, 53, 54
  - KNUCKLE, 51
  - KNUCKLE BALL STUD, 52
  - LINKAGE PITMAN ARM, 52
  - SPINDLE ASSY, 51
  - SPINDLE BEARING KIT, 51
- STEERING BOX REPAIR KIT, 73**
- STOP LAMP SWITCH, 19**
- STRAP, FUEL TANK (CENTER), 23**
- STUD KIT, STEERING KNUCKLE BALL, 51**
- STUD, FRONT WHEEL DISC BRAKE ASSY, 38**
- STUD, STEERING KNUCKLE BALL, 52**
- SUPPORT, CLUTCH RELEASE IDLER PIVOT, 28**
- SWITCH**
  - HEADLIGHT DIMMER, 18
  - IGNITION (W/O CYLINDER), 17
  - LIGHTING, 17
  - STOP LAMP, 19
- TACHOMETER, 21**
- TAIL & STOP LAMP LENS, 19**
- TAILGATE, 68**
- TAPPET, VALVE (W/ SNAP RING), 5**
- TEMPATROL, FAN DRIVE CLUTCH, 11**
- TEMPERATURE CONTROL CABLE, 62**
- THERMOSTAT HOUSING, 13**
- THERMOSTAT HOUSING GASKET, 13**
- THERMOSTAT, ENGINE COOLING, 13**
- THROWOUT LEVER BALL (IN HOUSING), 27**
- TIE ROD ASSY, 73**
- TIE ROD END ASSY**
  - PITMAN ARM STEERING ARM, 53
  - STEERING ARM TO STEERING ARM, 52
- TIMING CASE COVER**
  - ASSY, 7
  - GASKET, 7
  - GASKET SET, 7
  - SEAL, 7
- TIMING CHAIN, 7**
- TRANS & TRANSFER SHIFT LEVER BOOT, 30**
- TRANSFER CASE**
  - FRONT OUTPUT YOKE, 45
  - INSULATOR, 66
  - REAR OUTPUT YOKE, 45

# INDEX

## **TRANSMISSION KITS**

SMALL PARTS, 71  
GASKET SET, 71  
INTERMEDIATE SHAFT KIT, 71  
QUADRA TRAC CHAIN AND GASKET & SEAL SET, 71  
TRANSMISSION CONTROL HOUSING CAP, 30  
TRANSMISSION/TRANSFER CASE, 44  
TRANSMISSION (AUTOMATIC) OVER HAUL GASKET & SEAL KIT, 66  
TUBE, AIR CLEANER DUCT (HOT AIR), 22  
TUBE, HYDRAULIC CLUTCH, 29

**U-BOLT, FRONT & REAR SPRING, 56**  
**U-JOINTS, 46**

## **VALVE COVER KIT, 69**

VALVE PUSH ROD, 6  
VALVE ROCKER ARM, 6  
VALVE ROCKER ARM BALL BOLT, 6  
VALVE ROCKER ARM PIVOT, 6  
VALVE SPRING, 5  
VALVE SPRING KEEPER LOCK, 5  
VALVE SPRING RETAINER LOCK, 5  
VALVE TAPPET (W/ SNAP RING), 5  
VALVE  
EXHAUST, 5  
EXHAUST EMISSION BACKFIRE, 25  
INTAKE, 4  
PCV, 7  
VOLTMETER, 19

## **WASHER**

BRAKE SHOE ADJUSTING SCREW, 32  
BRAKE SHOE PARKING LEVER STRUT, 33  
FRONT WHEEL BEARING LOCK, 36  
FRONT WHEEL BEARING NUT LOCK, 37  
WATER PUMP, 13  
GASKET, 13  
TO THERMOSTAT HOUSING HOSE, 13  
WATER TEMPERATURE GAUGE, 20  
WATER TEMPERATURE SENDING UNIT, 20  
WEATHERSTRIP, WINDSHIELD, 70  
WINDSHIELD  
WIPER MOTOR, 68  
FRAME, 70  
GLASS WEATHERSTRIP CHANNEL, 70  
WASHER PUMP, 68  
WEATHERSTRIP, 70  
WIPER ARM, 68  
WIPER BLADE, 68  
WIPER CONTROL, 68  
WIPER MOTOR DRIVE LINK, 68  
WIPER SHAFT PIVOT ASSY, 68  
WIRE SET, IGNITION, 18

**YOKE KIT, FRONT PROPELLER SHAFT, 46**  
**YOKE**

AXLE PINION (FRONT AXLE), 45  
FRONT PROPELLER SHAFT, 46  
FRONT PROPELLER SHAFT UNIV JOINT SLEEVE, 45  
REAR PROPELLER SHAFT UNIV JOINT SLEEVE, 45  
TRANSFER CASE FRONT OUTPUT, 45  
TRANSFER CASE REAR OUTPUT, 45



# Holley® II

## Quality Remanufactured Carburetors

YEAR	ENGINE AND APPLICATION	BARRELS	MODEL	PART #
<b>Jeep 4 Cyl.</b>				
1987-84	2.46L 150" All/T (Inc. Alt./Cal.)	C-1	YFA	1604
1983	2.46L 150" S/T CJ (Fed.)	C-1	YFA	1588
	2.46L 150" S/T CJ (Alt/Cal.)	C-1	YFA	1469
1982	2.5L 151" S/T CJ (exe. Cal.)	R-2	2SE	70102
1981	2.5L 151" All/T CJ (exe. Cal.)	R-2	2SE	70102
1980	2.5L 151" S/T CJ (exe. Cal.)	R-2	2SE	7624
<b>Jeep 6 Cyl.</b>				
1987-86	4.2L 258" All/T (Inc. Alt./Cal.)	C-2	BBD	1591
1986-85	2.8L 173" All/T (exe. Cal.)	R-2	2SE	70099
1985-84	4.2L 258" All/T (Inc. Alt./Cal.)	C-2	BBD	1591
1984	2.8L 173" All/T (exe. Cal.)	R-2	2SE	70099
1983	4.2L 258" S/T CJ (Inc. Alt/Cal)	C-2	BBD	1591
	4.2L 258" A/T All (Cal)	C-2	BBD	1591
1982	4.2L 258" All/T CJ Exc. Hilly Terrain	C-2	BBD	1510

	4.2" 258" All/t CJ Hilly Terrain	C-2	BBD	1510
	4.2L 258" A/T CJ (Cal)	C-2	BBD	1591
	4.2L 258" S/T CJ (Cal)	C-2	BBD	1591
1981	4.2L 258" A/T CJ (exc. Cal)	C-2	BBD	1510
	4.2L 258" S/T CJ (exc. Cal)	C-2	BBD	1510
	4.2L 258" All/T CJ Hilly Terrain	C-2	BBD	1513
	4.2L 258" A/T CJ (Cal)	C-2	BBD	1592
	4.2L 258" S/T CJ (Cal)	C-2	BBD	1592
1980	4.2L 258" A/T CJ-7 (Fed)	C-2	BBD	1398
	4.2L 258" S/T CJ-5,7 (Fed)	C-2	BBD	1399
	4.2L 258" S/T CJ-5 Hilly Terrain	C-2	BBD	1400
1979	258" All/T	C-2	BBD	1157
1978	232" A/T, 258" All/T	C-1	YF	1153
	232" S/T, 258" S/T (Alt)	C-1	YF	1152
	258" All/T (H.D.)	C-2	BBD	1148
1977	232", 258" All/T	C-1	YF	1151
	232", 258" aLL/T (Alt)	C-1	YF	1150
1976	232", 258" All/T (Exc. 258 S/T CJ-5,7)	C-1	YF	1147
	258" S/T CJ-5,7	C-1	YF	1149
1975	232", 258" All/T	C-1	YF	1147
1974	232" S/T CJ-5,6 (Cal)	C-1	YF	2145
1973	232", 258" S/T All CJ-DJ	C-1	YF	1144
1972	232", 258"	C-1	YF	1232

### JEEP 8 Cyl.

1981	5.0L 304" A/T CJ (exc. Cal)	F-2	2150	5550
	5.0L 304" S/J CJ (exc. Cal)	F-2	2150	5551
1980	5.0L 304" All/t ch-5,7 (Inc/Cal)	F-2	2150	5308
1979	304" All/T CJ-5,7 (exc. Cal)	F-2	2100	5305
1978	304" All/T CJ-5,7 (Fed)	F-2	2100	5177
1978-77	304" All/t CJ-5,7 (Alt)	F-2	2100	5176
1977-76	304" S/T CJ-5,7 (Inc. Cal)	F-2	2100	5175
1976	304" A/T CJ-7 (Fed)	F-2	2100	5175
1975	304" S/T CJ-5,6	F-2	2100	5174

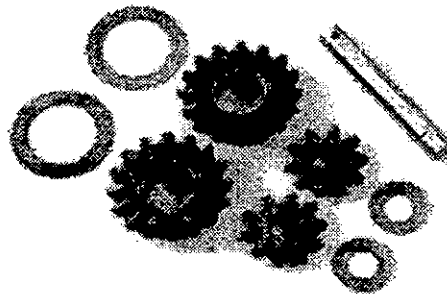

## DIFFERENTIAL REPAIR KITS

### CHRYSLER® / DODGE® / JEEP®

4746879	C7.25I	7-1/4" DIFF. KIT	\$69.95
4762774	C8.25I	8-1/4" DIFF. KIT	\$69.95
4798912	C9.25I	9-1/4" DIFF. KIT	\$69.95

26019829	GM10BI-30	87-96 GM	\$60.00
26019852	GM10BI-28	75-85 GM	\$60.00

# SUPERWINCH<sup>®</sup> HUBS

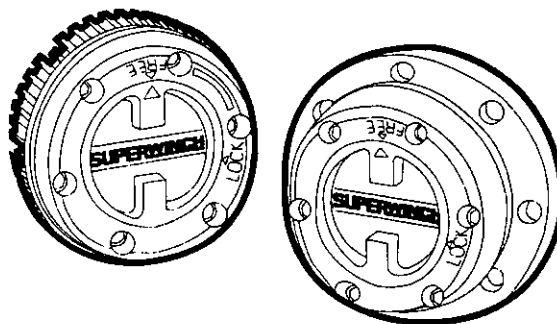

## SUPERWINCH HUB SPECIFICATION CHART

HUB P/N	APPLICATION/DESCRIPTION	NO. OF SPLINES	NO. OF BOLTS	B.C.D.		AXLE O.D.
				INCHES	MM	
400401	JEEP CJ '42-71, DANA 25/27	10	6	3.44	87.30	1-1/8
400402	JEEP CJ '72-80, DANA 30	27	6	3.44	87.30	1-3/16
400403	DAIHATSU ROCKY	26	5	3.54	90.00	28mm
400404	TOYOTA LAND CRUISER THRU '75	6	6	3.54	90.00	1-5/32
400405	LAND ROVER THRU '80	10	6	3.75	90.25	1-1/8
400406	LAND ROVER '81-90	24	6	3.75	90.25	1-1/4
400407	NISSAN PATROL THRU '79	10	6	3.48	88.00	1-7/32
400408	W300(MIL) POWER WAGON '57-75	16	6	4.00	101.60	1-3/8
400413	TOYOTA IF8, 4X4 '86.5-89	26	6	3.54	90.00	1-1/8
400417	DANA 44HD AXLE (EXT. MOUNT)	19	6	3.75	95.25	1-1/4
400418	DANA 44 AXLE	19	INTERNAL MOUNT			1-1/4
400419	LAND CRUISER '76-78	30	6	3.54	90.00	33mm
400420	DAIHATSU P.U. 4X4	26	5	3.54	90.00	28mm
400421	TOYOTA P.U. '79-85, L.C. '79-90	30	6	3.54	90.00	33mm
400422	CHEVY LUV, ISUZI 4X4	24	6	2.99	76.00	1-1/20
400423	NISSAN PATROL '80-87	29	6	3.54	90.00	1-3/16
400424	NISSAN 4X4 THRU '82	24	6	2.99	76.00	1
400426	JEEP CJ '81-86	27	5	3.44	87.30	1-3/16
400428	ARROW, D50 4X4	28	6	3.54	90.00	1-7/32
400429	NISSAN IFS '86.6-89	27	6	3.26	83.00	1-3/32
400430	SUZUKI SAMURAI '82-90	26	6	3.54	90.00	1-1/10
400432	TROOPER I, II, '83-86	24	6	3.15	80.00	1-1/20
400433	TROOPER II, '87-90	17	6	3.15	80.00	—
400434	REO/STUDEBAKER AXLE	16	8	5.5626	141.29	1-5/8
400435	MH 504 AXLE	10	8	5.125	130.18	—
400438	SIDEKICK/TRACKER '89-90	26	6	3.54	90.00	1-1/16
400439	DANA 60 1 TON	30	INTERNAL MOUNT			1-5/16
400441	DANA 70, DODGE 1TN W300 '79-89	30	8	3.96	100.58	1-5/16
400442	GMC 2.5 TON, 27 SPLINE	27	8	5.30	134.60	1-3/4
400443	D50, MONTERO '82-90	28	6	3.46	88.00	1-7/32
400444	NISSAN 4X4 P.U. '83-86	26	6	3.26	83.00	1-1/16
400445	NISSAN IFS '90	—	—	—	—	1-1/8

# SUPERWINCH<sup>®</sup> HUBS

**STAINLESS STEEL ACCESSORIES FROM CROWN AUTOMOTIVE**

<b>STAINLESS STEEL ACCESSORIES FOR CJ &amp; YJ</b>				
			<b>CJ</b>	<b>CJ &amp; YJ</b>
<b>PART NO.</b>	<b>TRADE #</b>	<b>DESCRIPTION</b>	<b>PRICE</b>	
488401	SS401	HOOD CATCH KIT. STAINLESS	6.85	YJ
488402	SS402	HOOD HINGES SET. STAINLESS	20.15	YJ
488403	SS403	W/S HINGES SET. STAINLESS	50.10	YJ
488407	SS407	LOWER DOOR BRACKET KIT. STAINLESS	11.33	YJ
488408	SS408	INTER. W/S MOUNT KIT STAINLESS	9.70	
488411	SS411	W/S TIE DOWN KIT. STAINLESS	5.66	
488414	SS414	TIRE STOP, TAILGATE. STAINLESS	12.55	
488415	SS415	ENTRY GUARD SET. STAINLESS	7.65	
488416	SS416	ENTRY GUARD SET. STAINLESS	10.03	YJ
488419	SS419	LOWER T/GATE HINGES. STAINLESS	20.15	
488420	SS420	HINGES, FULL STEEL DOOR. STAINLESS	35.87	YJ
488424	SS424	STONEGUARD SET (6 PCS) STAINLESS	29.74	
488425	SS425	STONEGUARD SET (6 PCS) STAINLESS	31.01	
488426	SS426	STONEGUARD SET BILLET STYLE. ST.ST	31.90	
488438	SS438	REAR BUMPERETTES. STAINLESS	45.90	
488441	SS441	HINGES, 1/2 DOOR. STAINLESS	37.81	YJ
488442	SS442	TAILGATE HINGES. STAINLESS	54.14	YJ
488445	SS445	FRONT FRAME COVER. STAINLESS	36.48	
488499	SS499	HOOD SET. STAINLESS STEEL	45.68	
488504	SS504	MIRROR KIT, CHROME YJ 1/2 DOOR	58.95	
488527	SS527	W/S KNOBS	13.41	
488694	SS694	MIRROR KIT, BLACK YJ 1/2 DOOR	48.79	
488699	SS699	HOOD SET, BLACK	37.83	
5764665		BATTERY TRAY, CJ'S	17.50	
5764665-ST		BATTERY TRAY, CJ'S STAINLESS STEEL	32.00	
3226119		BATTERY CLAMP - BLACK	1.60	
3226119ST		BATTERY CLAMP - STAINLESS	3.50	

**ACCESSORIES ARE INDIVIDUALLY PACKAGED IN BEAUTIFUL H.D. BOXES**



Printed on recycled paper



**MAIN OFFICE**

340 Oak Street  
North Pembroke, MA 02358

(781) 826-6200 (800) 343-9666

FAX # (781) 826-4097

**WESTERN BRANCH**

161 S. Kernite Street  
Tooele, UT 84074

TOLL FREE (800) 453-8220

FAX # (800) 795-2476

**SOUTHERN BRANCH**

955 Hurricane Shoals Road, Suite 101  
Lawrenceville, GA 30243

(404) 339-0862 (800) 241-9462

FAX # (800) 221-5957

**Crown Automotive Sales Co., Inc.**

Independent Distributor of Replacement Parts for Jeep® Vehicles